

MAIN POWER CONNECTION

L2 N L1 G

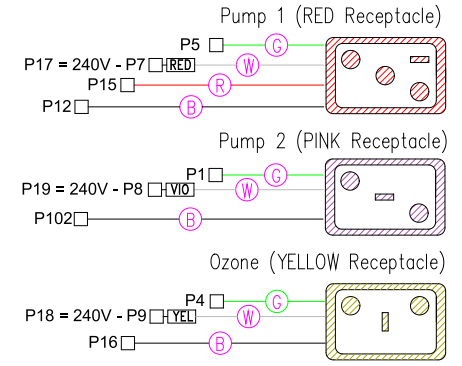

HL
34-02010-76 - High-Limit Sensor - 76"

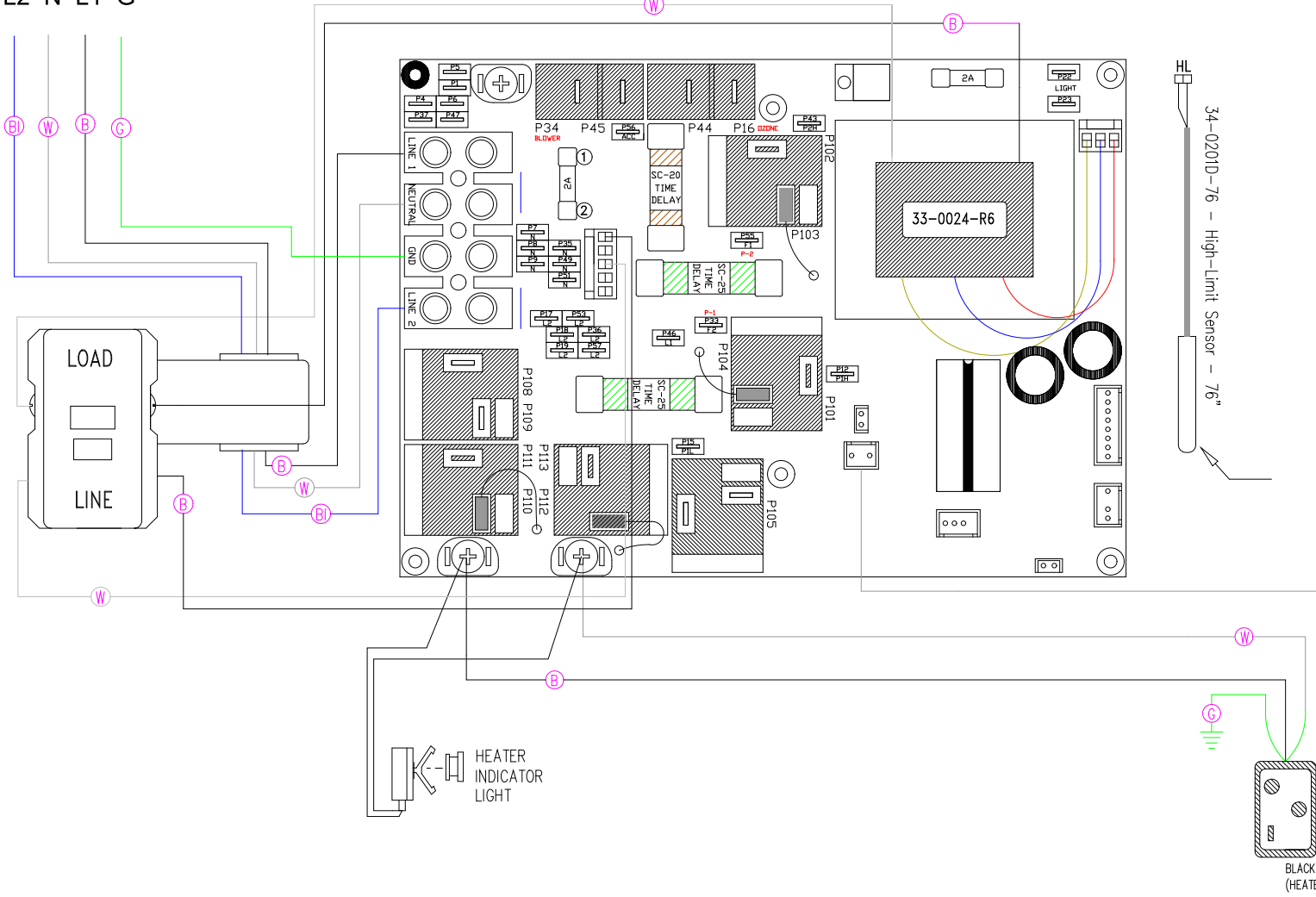
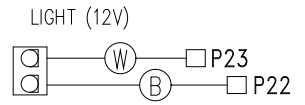
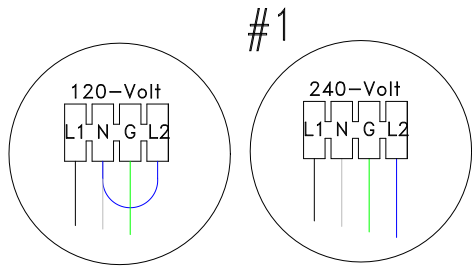
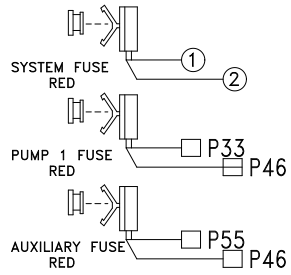
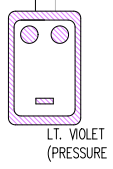
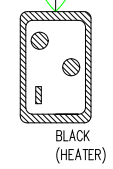

LEGEND	
	- 1/4" QUICK CONNECT
	- 1/4" QUICK CONNECT PIGGYBACK
	- FORK CONNECTOR
	- RING CONNECTOR
	- SOCKET CONNECTOR
	- PIN CONNECTOR

HYDRO-QUIP
CORONA, CA (951) 273-7575

Manufacture Notes:

#1 Line 2 and Neutral need to be jumpered for 120V operation.

Drawn MBS	Rev 01	Wire Color Code B - Black G - Green Br - Brown Bl - Blue R - Red Y - Violet O - Orange W - White Y - Yellow Gr - Gray
Date 03.17.09		
Diagram No. 6832		