

# MAIN POWER CONNECTION

L2 N L1 G

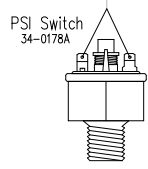
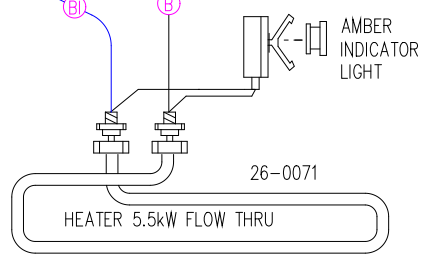
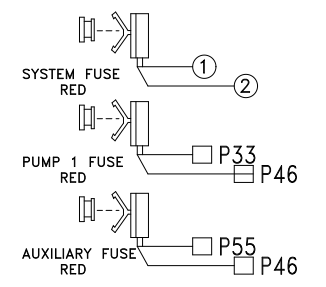
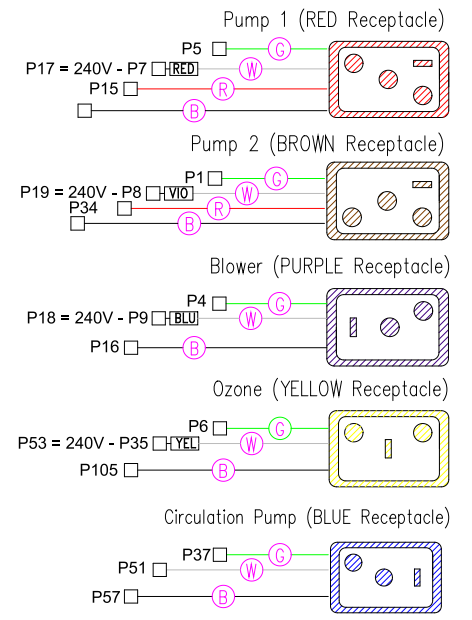
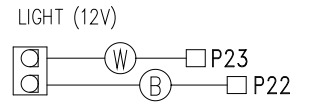
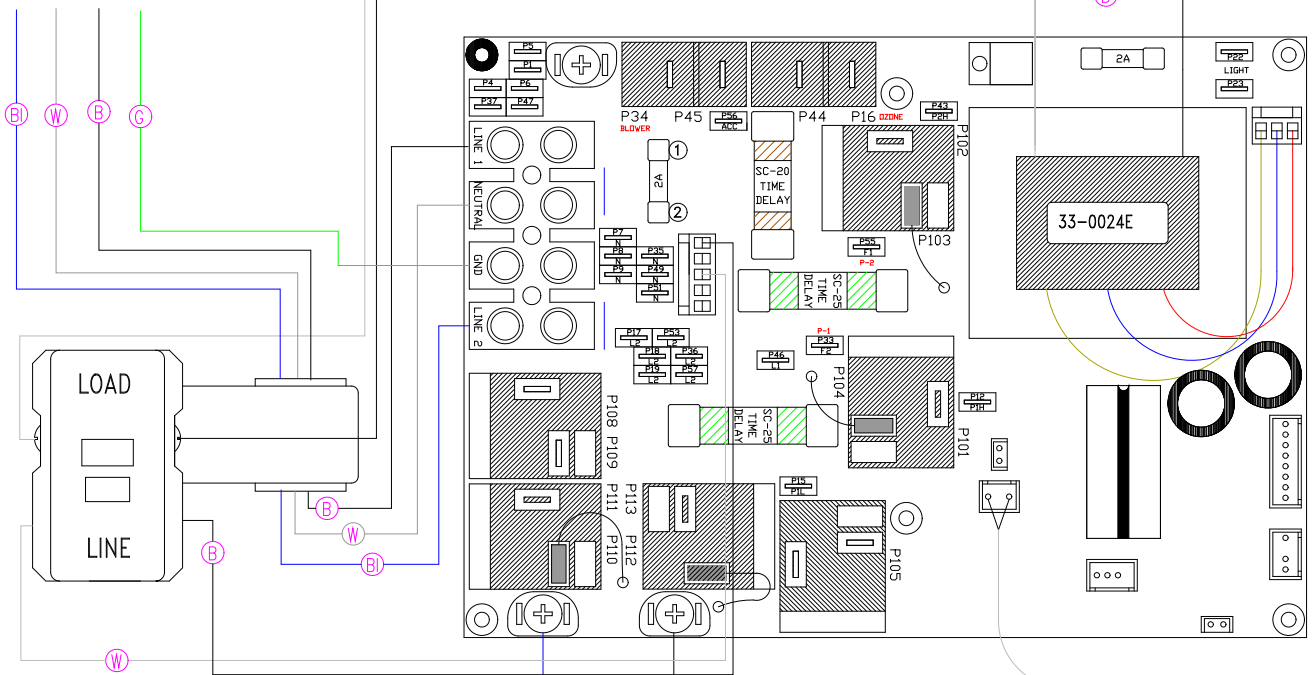
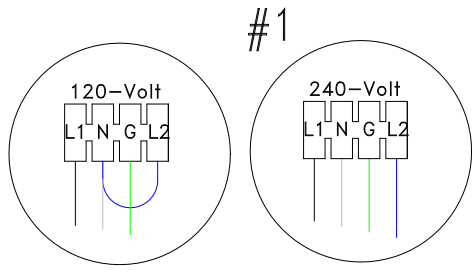

LEGEND	
	- 1/4" QUICK CONNECT
	- 1/4" QUICK CONNECT PIGGYBACK
	- FORK CONNECTOR
	- RING CONNECTOR
	- SOCKET CONNECTOR
	- PIN CONNECTOR

**HYDRO-QUIP**  
CORONA, CA (951) 273-7575

**Manufacture Notes:**

#1 Line 2 and Neutral need to be jumpered for 120V operation.

Drawn MBS	Rev 01	Wire Color Code B - Black      G - Green Br - Brown    Bl - Blue R - Red        V - Violet O - Orange    W - White Y - Yellow     Gr - Gray
Date 12.22.08		
Diagram No. 6828		