

MAIN POWER CONNECTION

L2 N L1 G

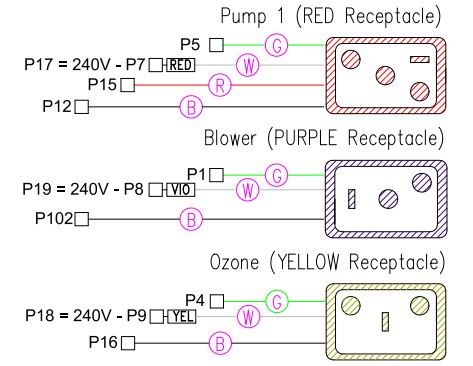
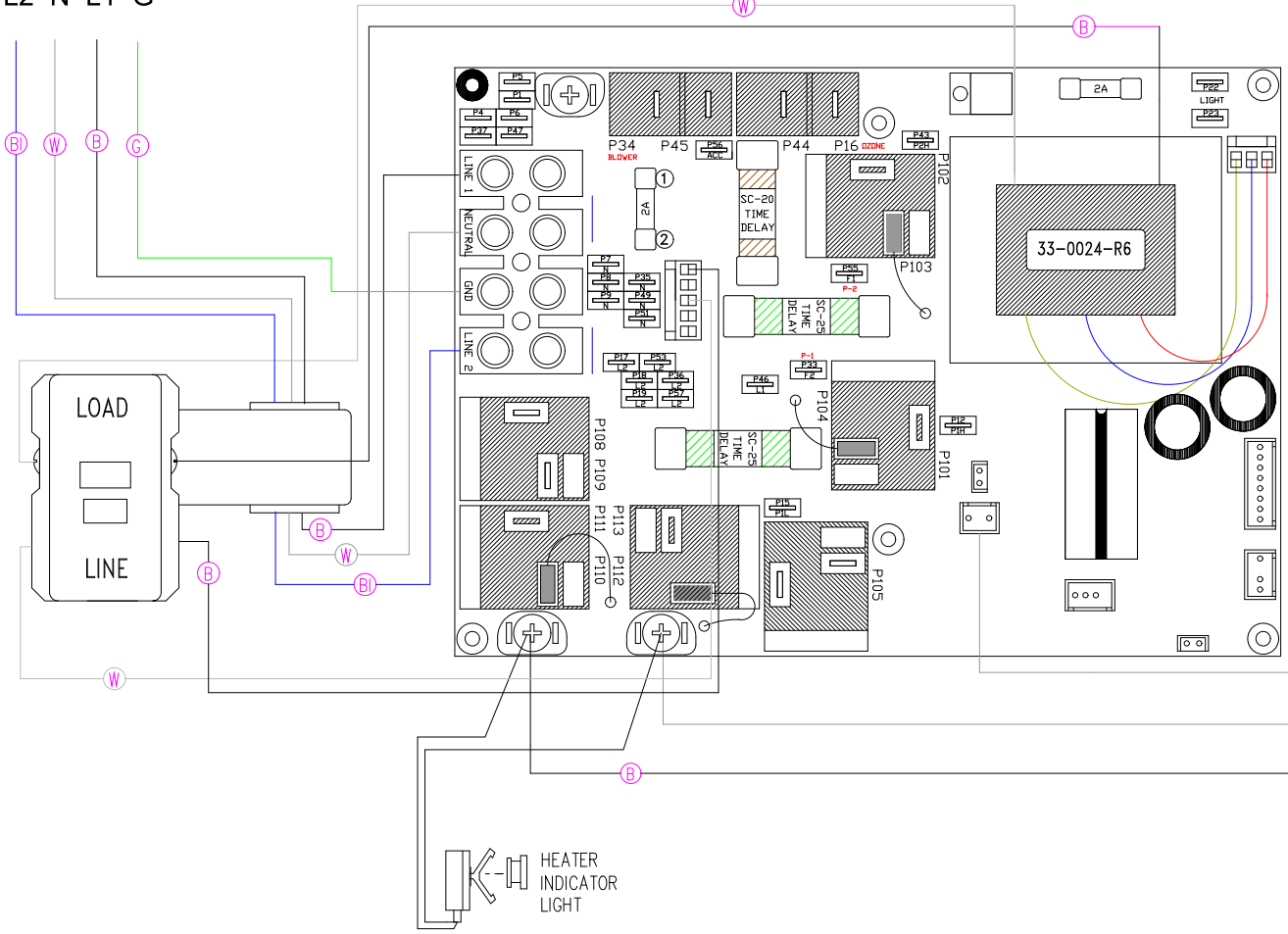
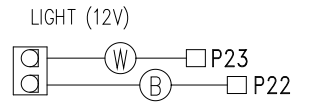
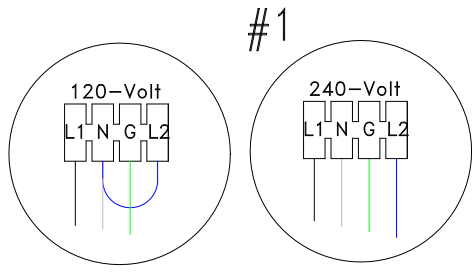
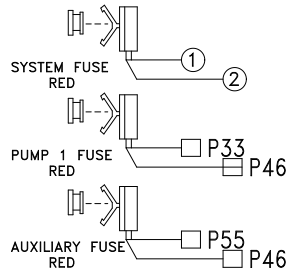

LEGEND	
	- 1/4" QUICK CONNECT
	- 1/4" QUICK CONNECT PIGGYBACK
	- FORK CONNECTOR
	- RING CONNECTOR
	- SOCKET CONNECTOR
	- PIN CONNECTOR

HYDRO-QUIP
CORONA, CA (951) 273-7575

Manufacture Notes:

#1 Line 2 and Neutral need to be jumpered for 120V operation.

Drawn MBS	Rev 02	Wire Color Code B - Black G - Green Br - Brown Bl - Blue R - Red V - Violet O - Orange W - White Y - Yellow Gr - Gray
Date 12.18.08		
Diagram No. 6826		