

MAIN POWER CONNECTION

L2 N L1 G

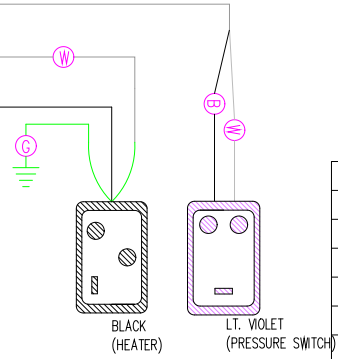
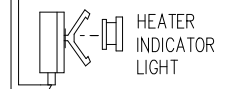
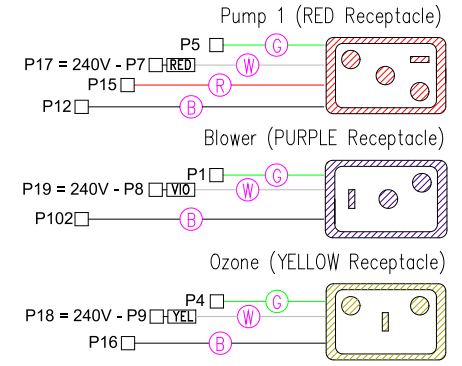
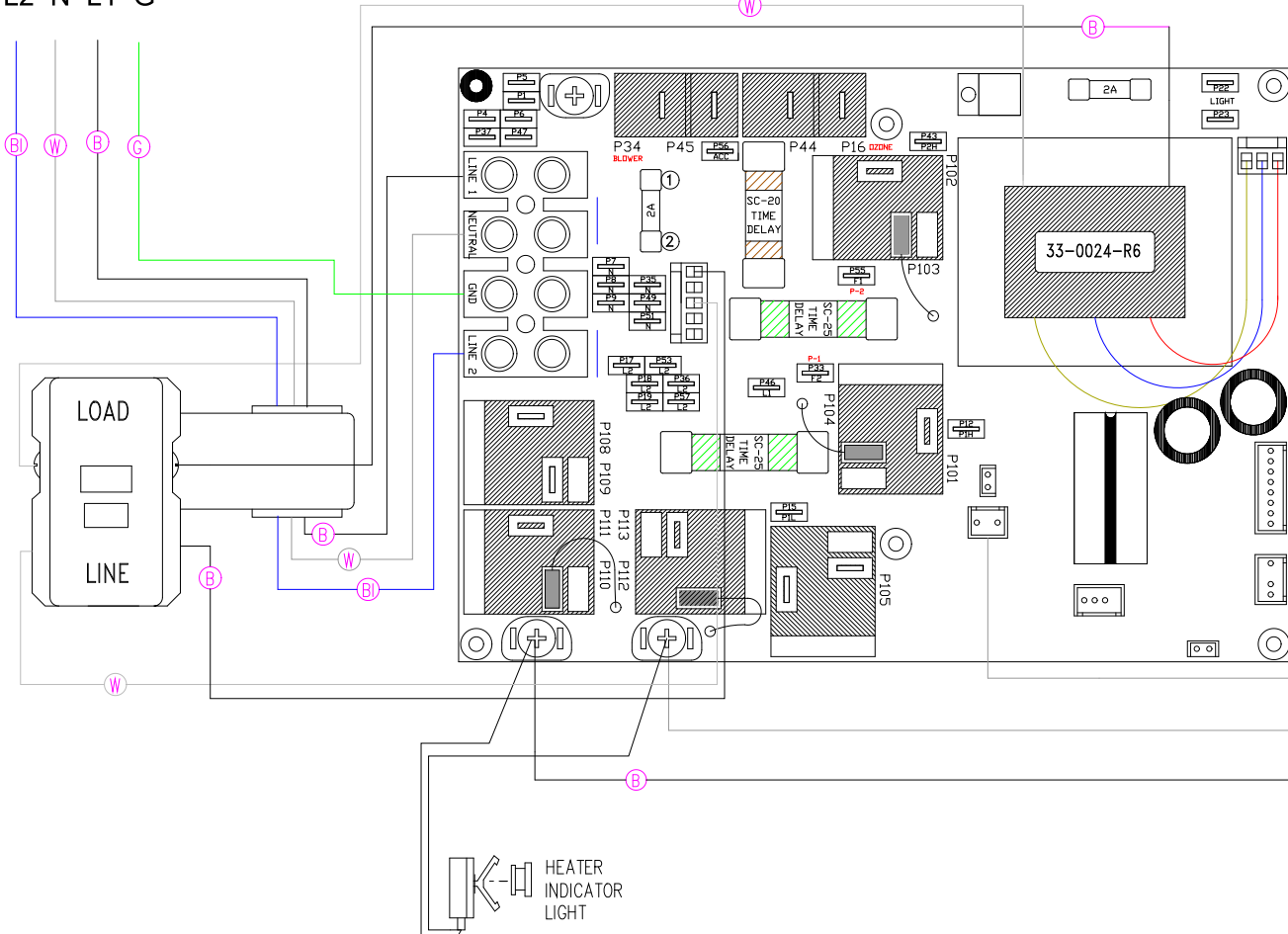
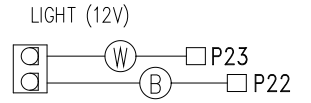
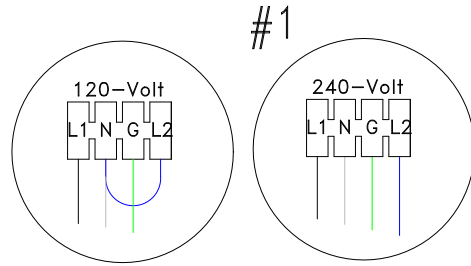
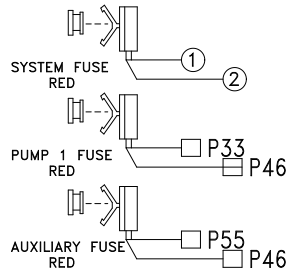

LEGEND	
	- 1/4" QUICK CONNECT
	- 1/4" QUICK CONNECT PIGGYBACK
	- FORK CONNECTOR
	- RING CONNECTOR
	- SOCKET CONNECTOR
	- PIN CONNECTOR

HYDRO-QUIP
CORONA, CA (951) 273-7575

Manufacture Notes:

#1 Line 2 and Neutral need to be jumpered for 120V operation.

Drawn	Rev	Wire Color Code
MBS	02	
Date	12.18.08	B - Black G - Green
Diagram No.	6826-AL	Br - Brown Bl - Blue
		R - Red V - Violet
		O - Orange W - White
		Y - Yellow Gr - Gray