

**TO CONVERT CIRCUIT 120V OR 240V MOVE WHITE WIRE ACCORDINGLY**  
**120V COMPONENT = OPEN POSITION AT CONNECTION BLOCK #4**  
**240V COMPONENT = OPEN POSITION AT CONNECTION BLOCK #2**

26-0063-M7 - Gas Housing

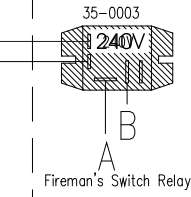

BACK OF PCB MOUNTING PLATE

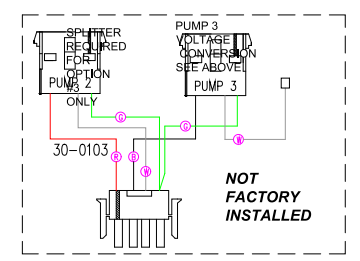
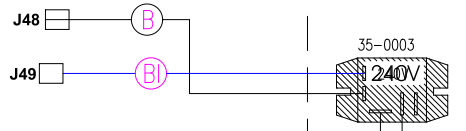
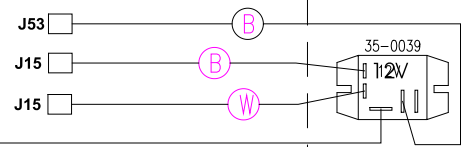
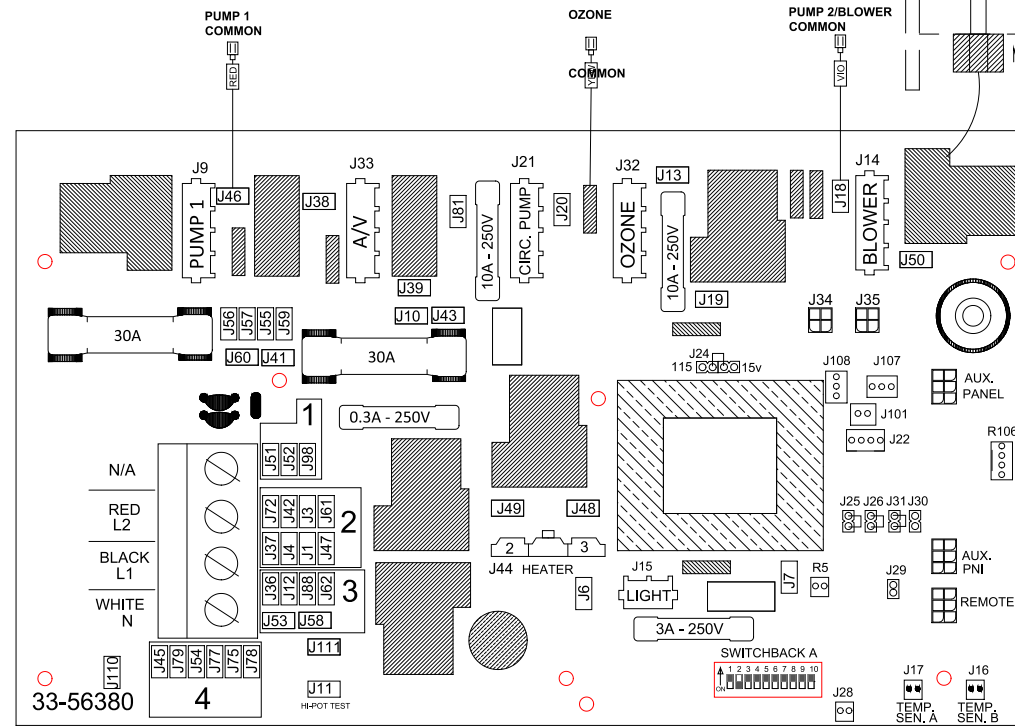
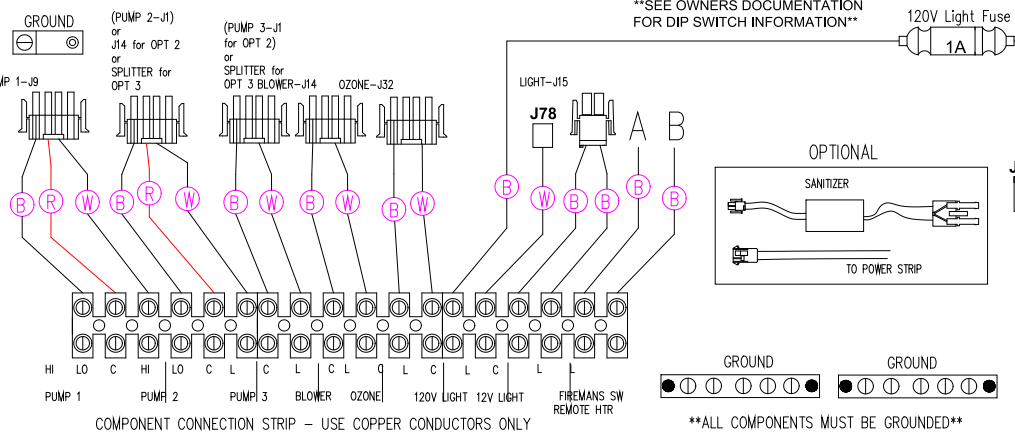

\*\*SEE OWNERS DOCUMENTATION FOR DIP SWITCH INFORMATION\*\*

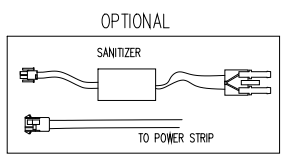
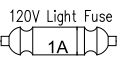

\*\*ALL COMPONENTS MUST BE GROUNDED\*\*

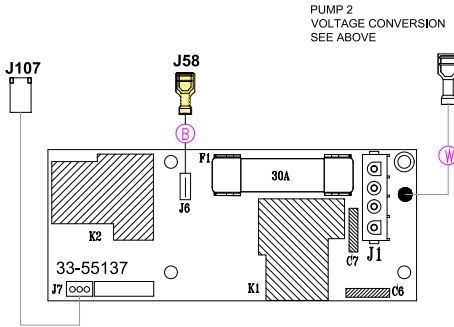

PUMP 2 VOLTAGE CONVERSION SEE ABOVE

**CONFIGURATION OPTIONS**

**DEFAULT/FACTORY CONFIGURATION:** PUMP 1=2-SPEED, PUMP 2=1-SPEED, BLOWER

**OPTION 1 (SETUP #3) - 2 SPEED PUMP #2 & BLOWER:** REFER TO INSTALLATION MANUAL SYSTEM CONFIGURATION.

**OPTION 2 (SETUP #2) - 2-SPEED PUMP #2 & PUMP #3:** PUMP #2 PLUGS INTO (J14). PUMP #3 PLUGS INTO AUX PCB (J1).

**OPTION 3 (SETUP #5) - 1-SPEED PUMP #2, BLOWER & PUMP #3:** PUMP #2 & PUMP #3 PLUGS INTO AUX PCB SPLITTER CONNECTED TO (J1).

**\*\*SEE INSTALLATION MANUAL FOR DIP SWITCH SETTINGS\*\***

**HYDRO-QUIP**  
CORONA, CA (951) 273-7575

Manufacture Notes:

Dwg. No. **G822A0-KLPQY-J**

Drawn **MO** Rev **05**

Wire Color Code

DEFAULT SYSTEM SETUP: #18 - REFER TO INSTALLATION MANUAL

Date **12.22.16**  
Diagram No. **5183**

B - Black G - Green  
 Br - Brown Bl - Blue  
 R - Red V - Violet  
 O - Orange W - White  
 Y - Yellow Gr - Gray