

TO CONVERT CIRCUIT 120V OR 240V MOVE WHITE WIRE ACCORDINGLY
 120V COMPONENT = WHT AC/NEUTRAL
 240V COMPONENT = RED AC/LINE 2

26-0054-M7 - 5.5kW Heater

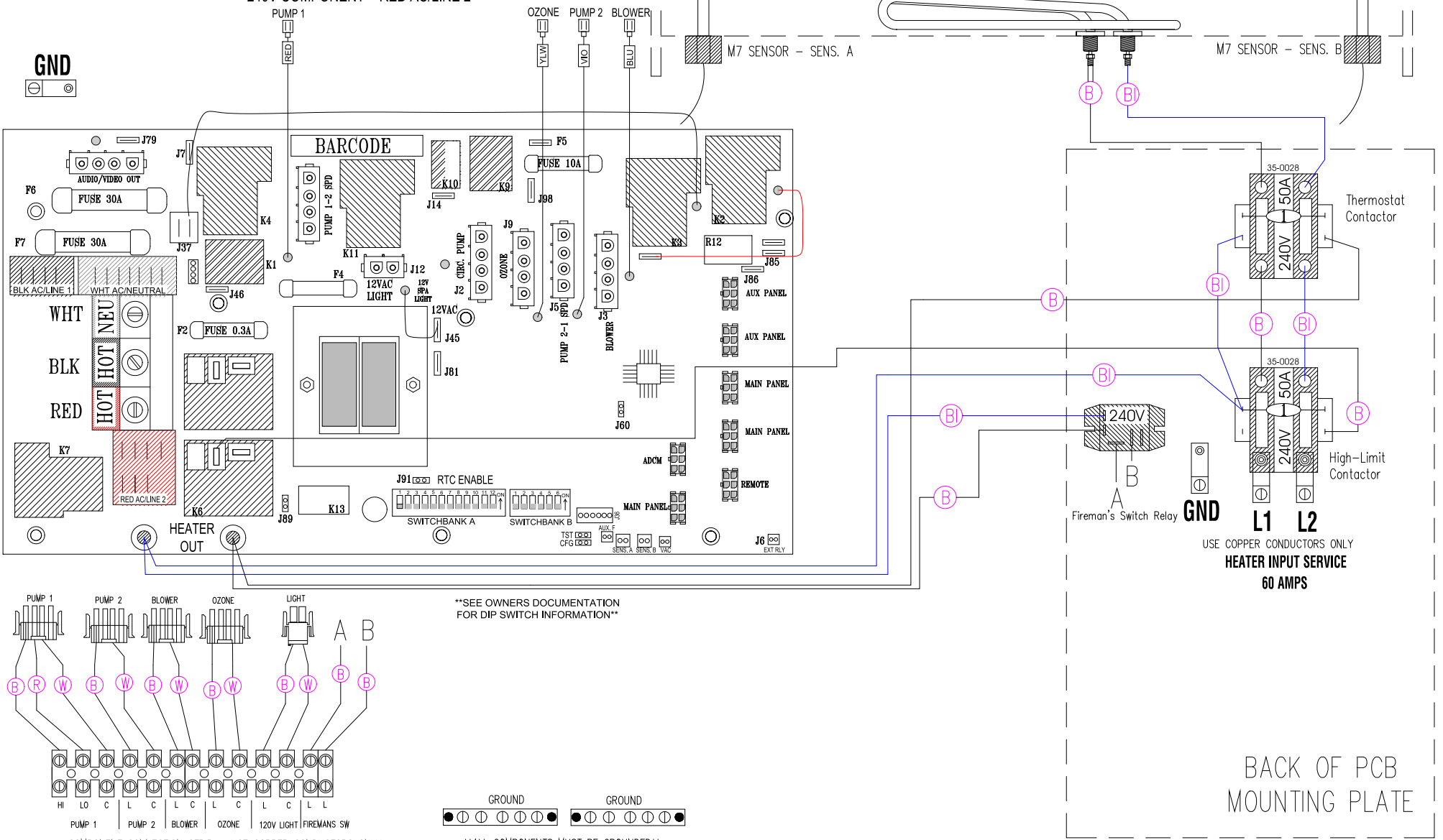

SEE OWNERS DOCUMENTATION FOR DIP SWITCH INFORMATION

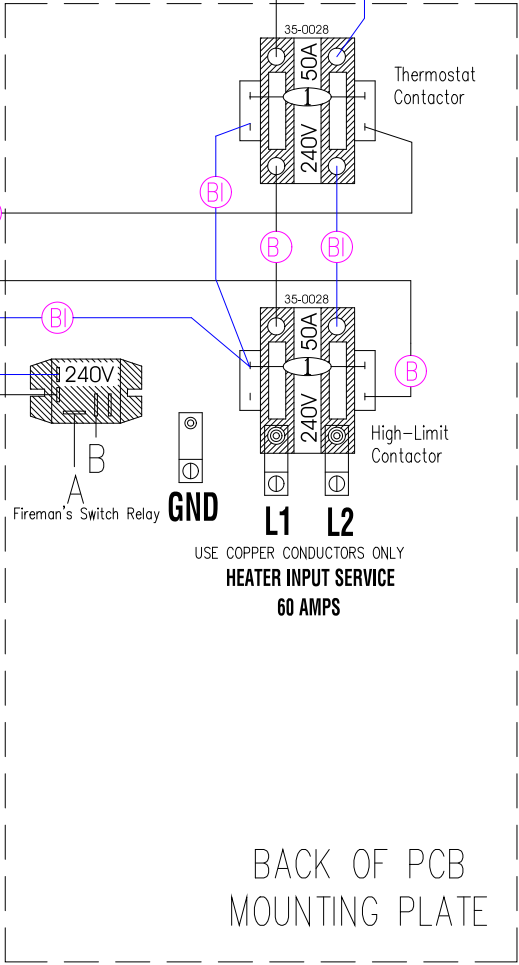
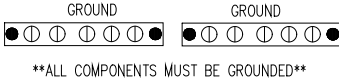
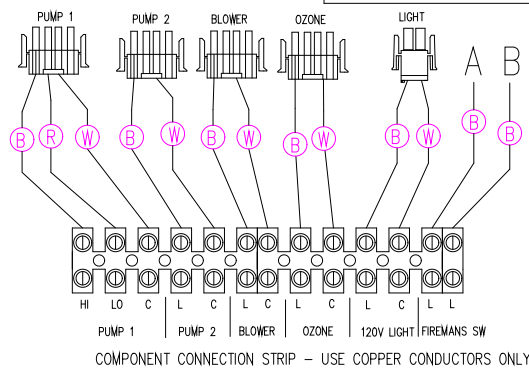

USE COPPER CONDUCTORS ONLY
 HEATER INPUT SERVICE
 60 AMPS

BACK OF PCB
 MOUNTING PLATE

HYDRO-QUIP
 CORONA, CA (951) 273-7575

Manufacture Notes:

Dwg. No.
 G822A0-KLPQY-J

Drawn MBS
 Date 11.21.11
 Diagram No. 5172

Rev 02
 Wire Color Code
 B - Black G - Green
 Br - Brown BI - Blue
 R - Red V - Violet
 O - Orange W - White
 Y - Yellow Gr - Gray

DIP SWITCHES & PERSISTANT MEMORY: TO MAKE CHANGES TO THE CONFIGURATION DIP SWITCHES PERSISTANT MEMORY MUST BE RESET. 1) POWER SYSTEM OFF, 2)TURN SWITCH A12 "ON" AND MAKE DESIRED CHANGES TO THE DIP-SWITCH(S), 3) POWER SYSTEM BACK ON, LET THE SYSTEM BOOT UP COMPLETELY, CHECK THAT DESIRED CHANGES WERE MADE, 4) POWER SYSTEM OFF AND TURN SWITCH A12 "OFF" (IF USING A NON-CONDUCTIVE TOOL THE SWITCH MAY BE TURNED OFF WHILE THE POWER IS ON)

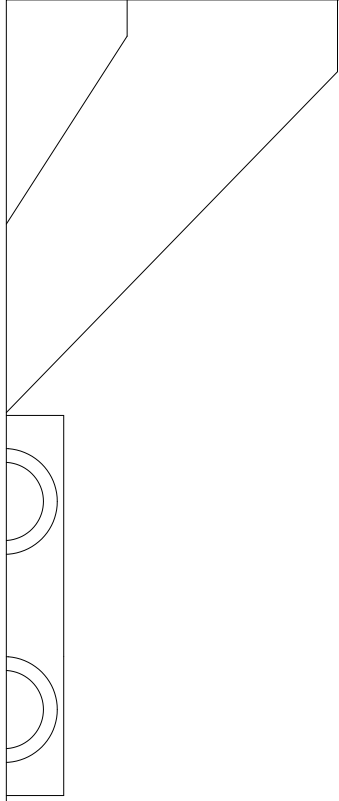

GROUND

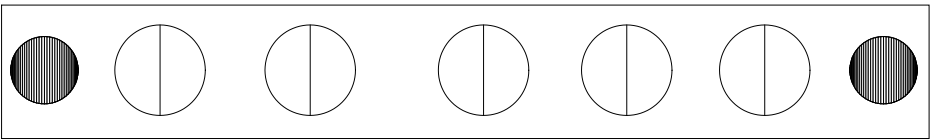

NS SW

CTORS ONLY

**ALL COMPONENTS MUS

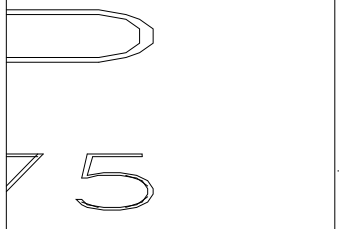

Manufacture Notes: