

LEGEND

- - 1/4" QUICK CONNECT
- ▭ - 1/4" PIGGYBACK
- ⊞ - FORK CONNECTOR
- - RING CONNECTOR
- ◻ - SOCKET CONNECTOR
- △ - PIN CONNECTOR

33-0027-R2

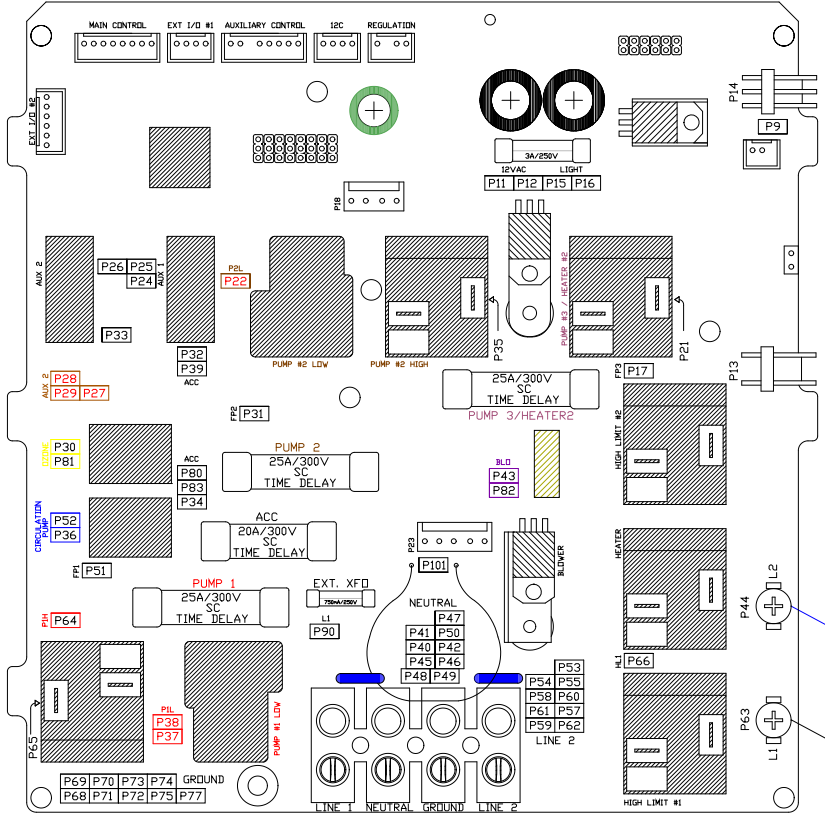

USE COPPER CONDUCTORS ONLY
MAIN INPUT SERVICE
SEE MANUAL

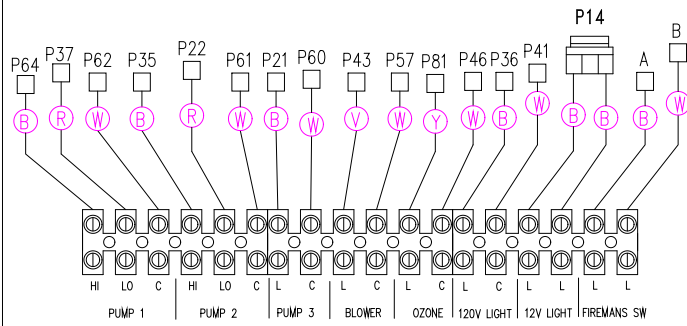
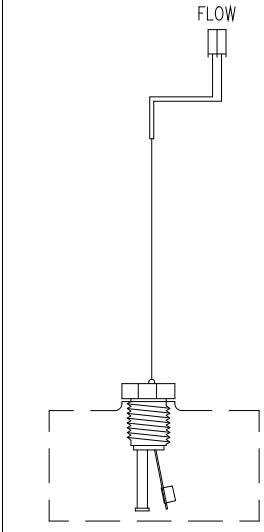

COMPONENT CONNECTION STRIP - USE COPPER CONDUCTORS ONLY



ALL COMPONENTS MUST BE GROUNDED

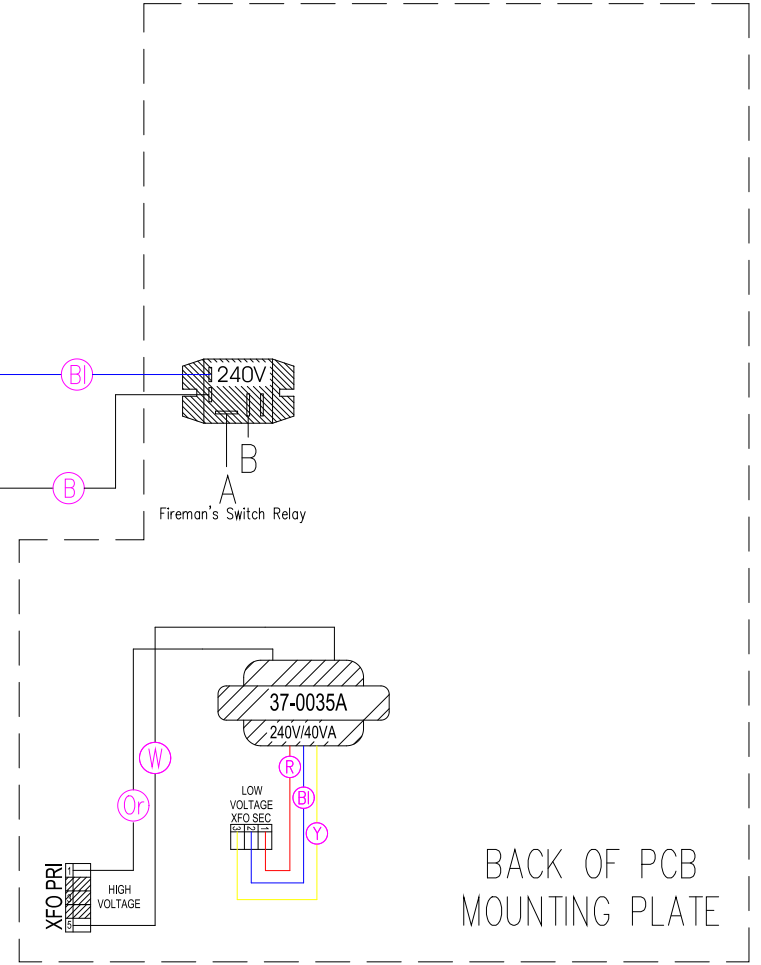

BACK OF PCB
 MOUNTING PLATE

HYDRO-QUIP
 CORONA, CA (951) 273-7575

Manufacture Notes:

Dwg. No.
G822A0-KLPQY-J

Drawn
 MBS
 Date
 08.30.12
 Diagram
 No.
5170

Rev
 02
Wire Color Code
 B - Black G - Green
 Br - Brown Bl - Blue
 R - Red V - Violet
 O - Orange W - White
 Y - Yellow Gr - Gray

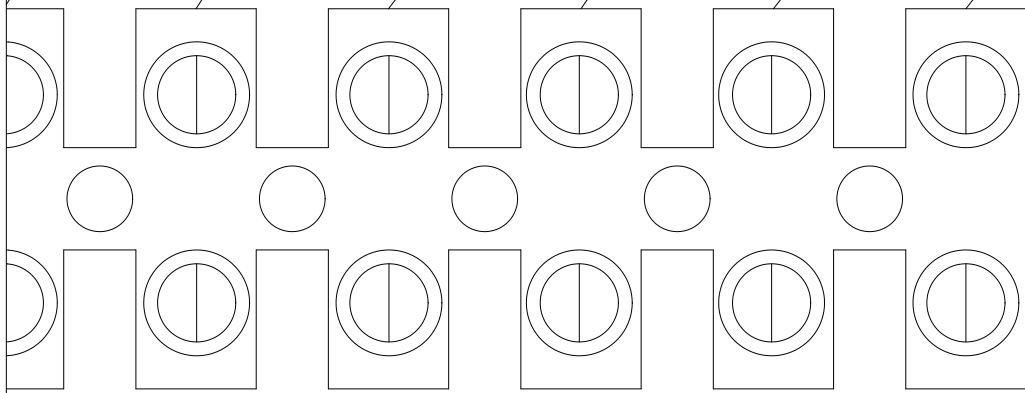
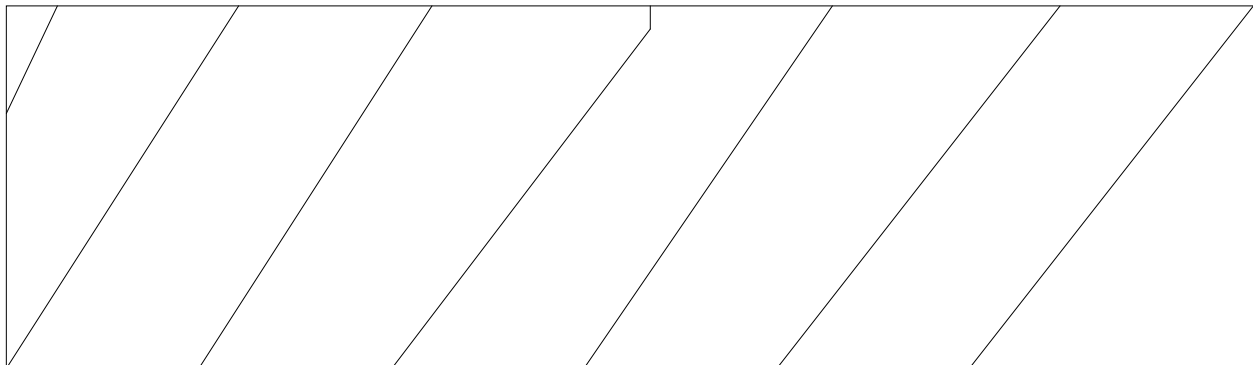

L	C	L	L	L	L	L
20V LIGHT		12V LIGHT		FIREMANS SW		

CONDUCTORS ONLY

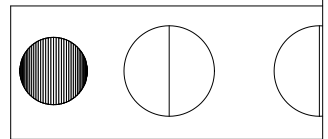

**AL

75

Manufacture Notes: