

**LEGEND**

- - 1/4" QUICK CONNECT
- ▭ - 1/4" PIGGYBACK
- ⊞ - FORK CONNECTOR
- - RING CONNECTOR
- ◻ - SOCKET CONNECTOR
- △ - PIN CONNECTOR

33-0027-R1

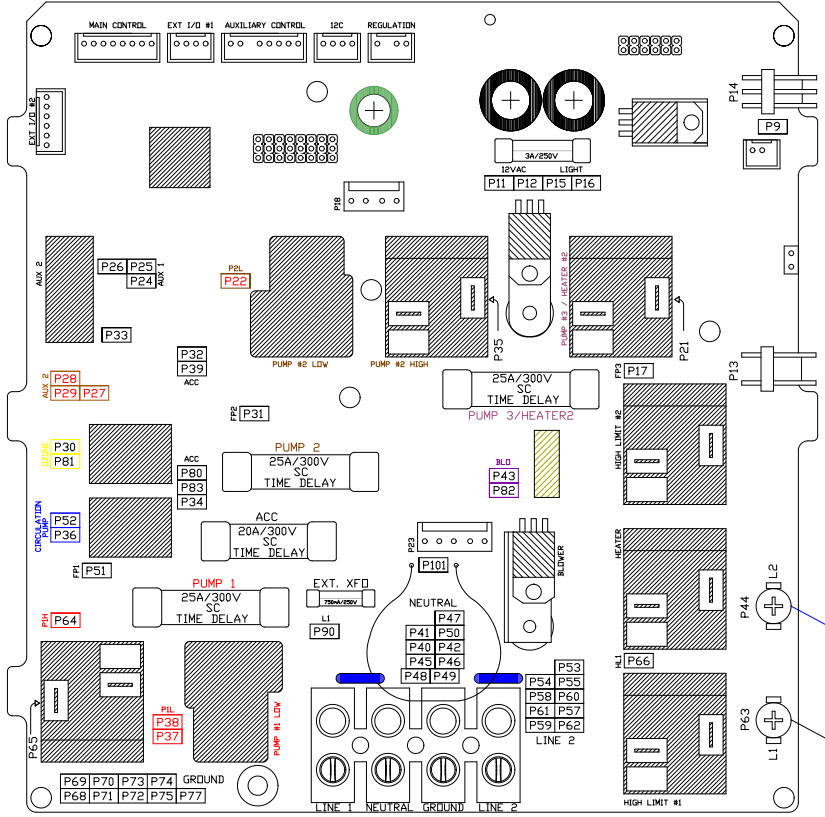

USE COPPER CONDUCTORS ONLY  
**MAIN INPUT SERVICE**  
 SEE MANUAL

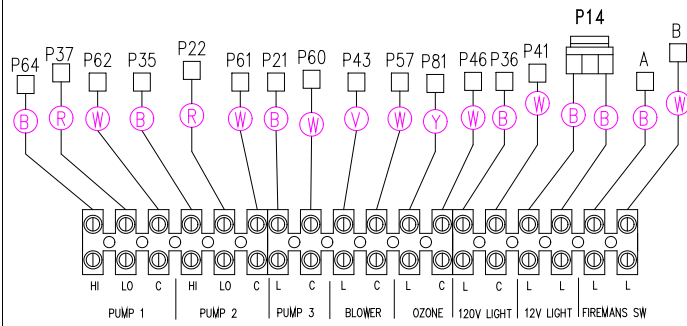
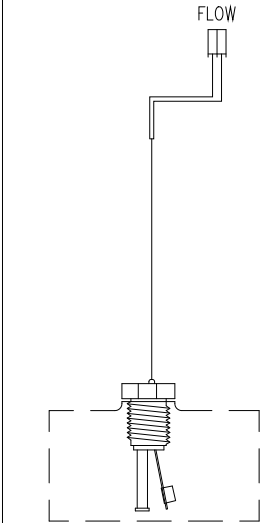

COMPONENT CONNECTION STRIP - USE COPPER CONDUCTORS ONLY



**\*\*ALL COMPONENTS MUST BE GROUNDED\*\***

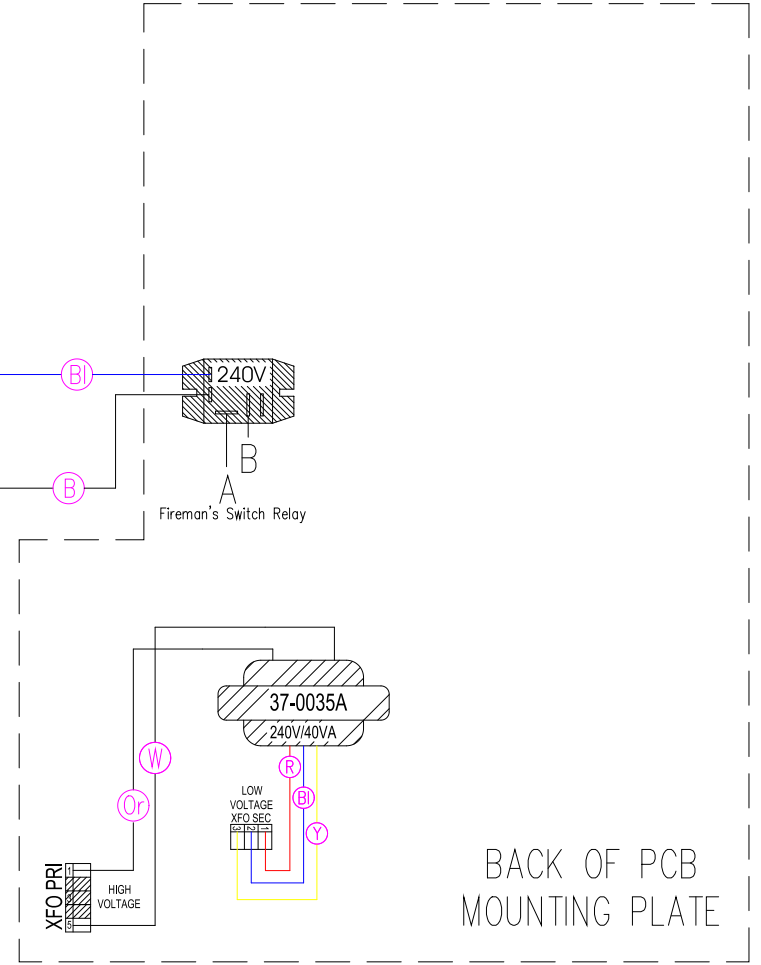

BACK OF PCB  
 MOUNTING PLATE

**HYDRO-QUIP**  
 CORONA, CA (951) 273-7575

Manufacture Notes:

Dwg. No.  
**G822A0-KLPQY-J**

Drawn MBS  
 Date 10.18.11  
 Diagram No. **5170**

Rev 01  
**Wire Color Code**  
 B - Black G - Green  
 Br - Brown Bl - Blue  
 R - Red V - Violet  
 O - Orange W - White  
 Y - Yellow Gr - Gray

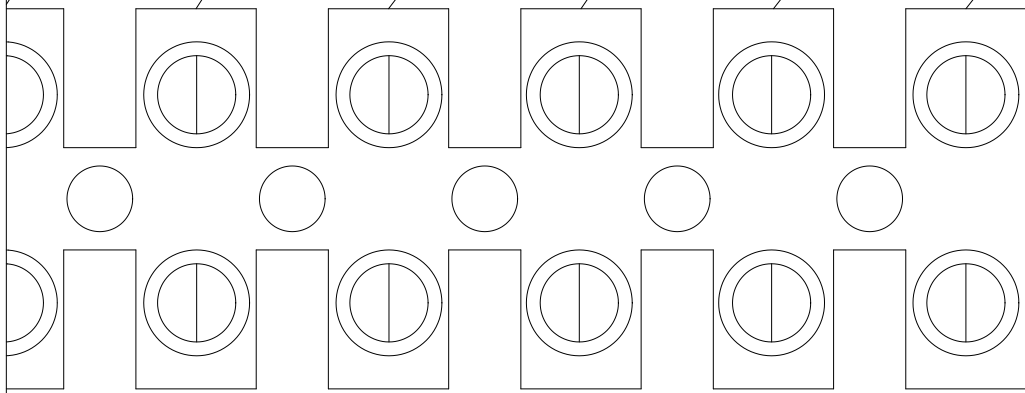
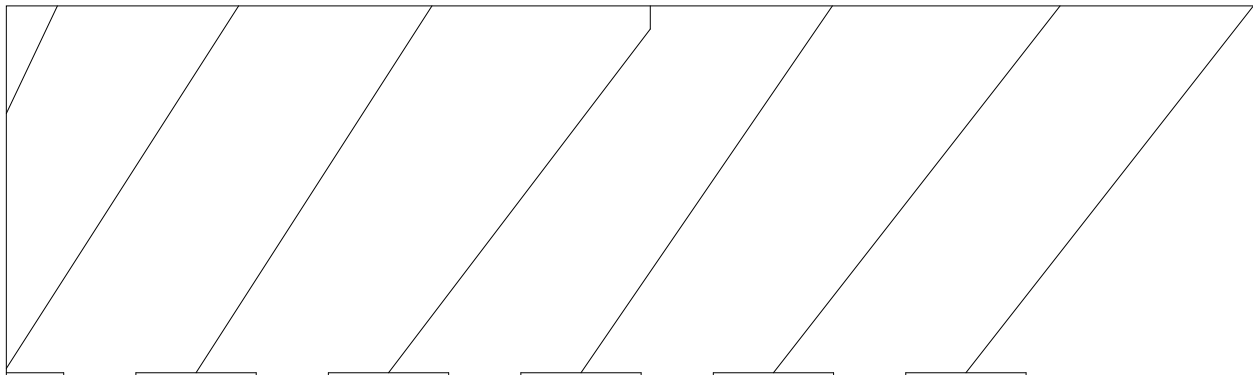

|           |   |           |   |             |   |   |
|-----------|---|-----------|---|-------------|---|---|
| L         | C | L         | L | L           | L | L |
| 20V LIGHT |   | 12V LIGHT |   | FIREMANS SW |   |   |

CONDUCTORS ONLY

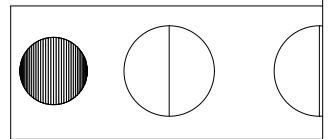

\*\*AL

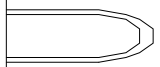

75

Manufacture Notes: