

**LEGEND**

- - 1/4" QUICK CONNECT
- ▭ - 1/4" PIGGYBACK
- ⊞ - FORK CONNECTOR
- - RING CONNECTOR
- ◻ - SOCKET CONNECTOR
- △ - PIN CONNECTOR

33-0027-R2

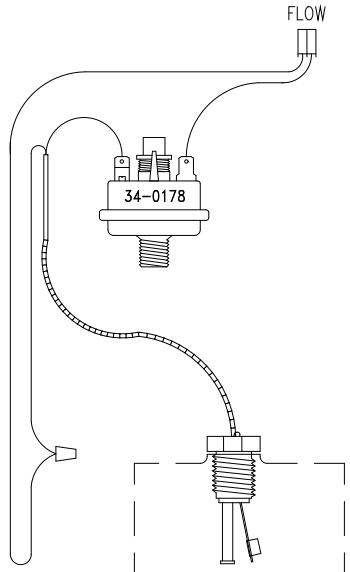
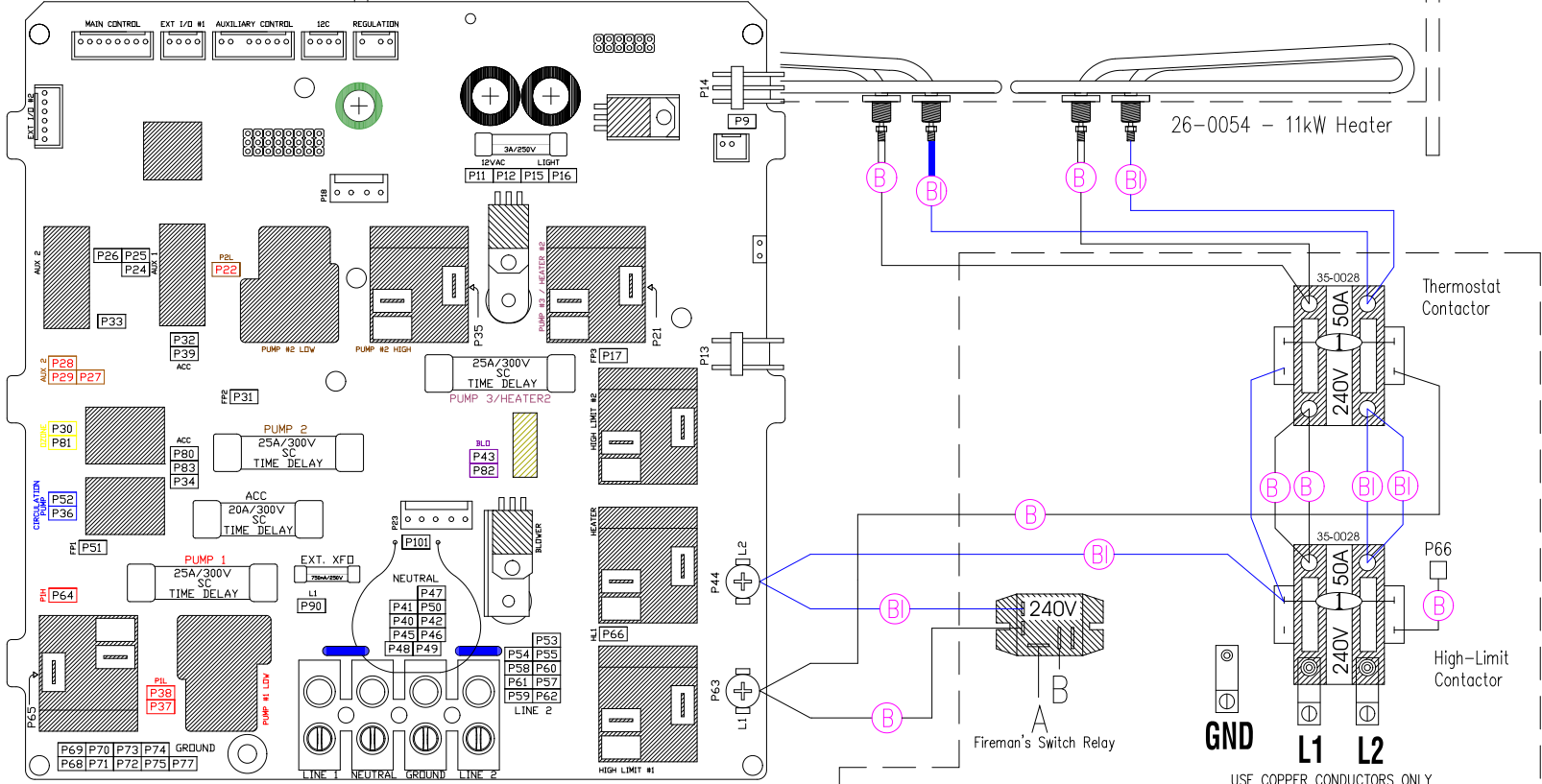

USE COPPER CONDUCTORS ONLY  
**MAIN INPUT SERVICE**  
 SEE MANUAL

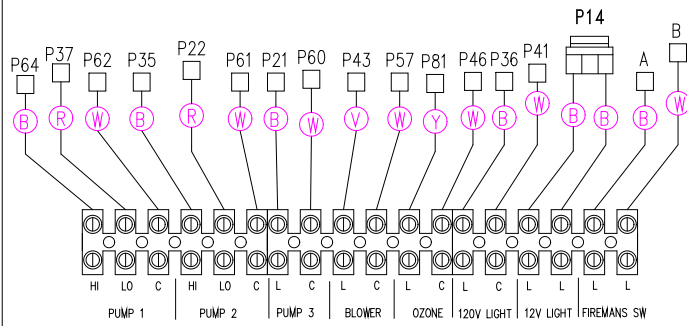

COMPONENT CONNECTION STRIP - USE COPPER CONDUCTORS ONLY



\*\*ALL COMPONENTS MUST BE GROUNDED\*\*

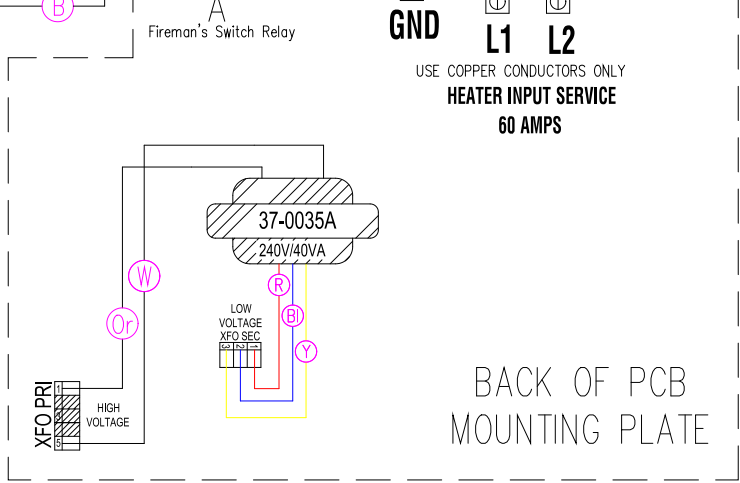

**HYDRO-QUIP**  
 CORONA, CA (951) 273-7575

Manufacture Notes:

Dwg. No. **G822A0-KLPQY-J**

Drawn **MBS** Rev **11**  
 Date **08.30.12**  
 Diagram No. **5152**

Wire Color Code

B - Black	G - Green
Br - Brown	Bl - Blue
R - Red	V - Violet
O - Orange	W - White
Y - Yellow	Gr - Gray

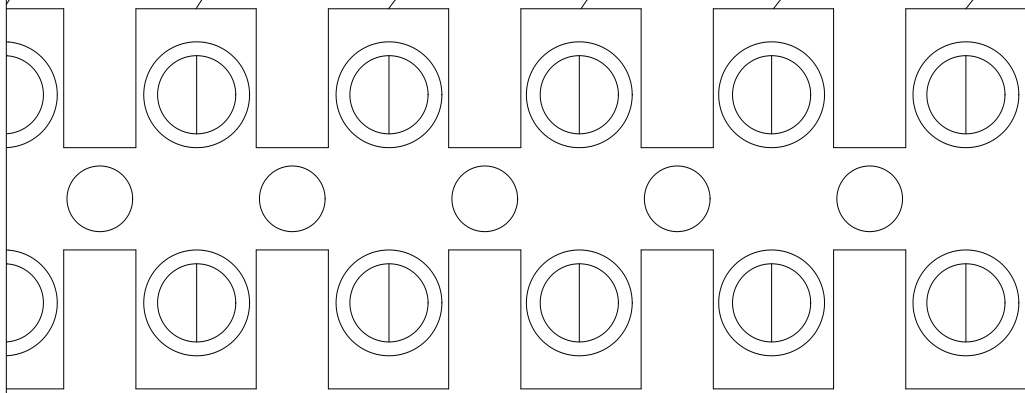
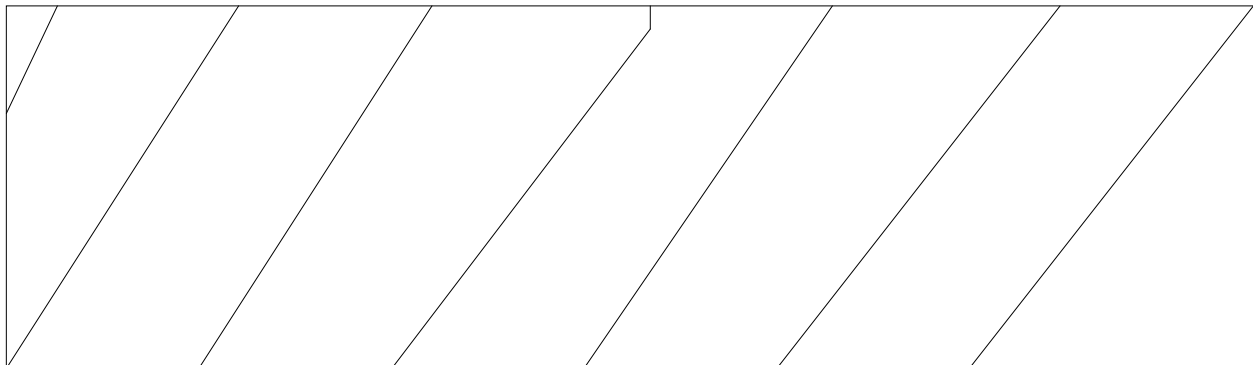

L	C	L	L	L	L	L
20V LIGHT		12V LIGHT		FIREMANS SW		

CONDUCTORS ONLY

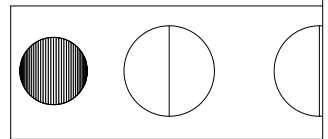

\*\*AL

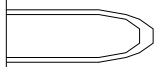

75

Manufacture Notes: