

LEGEND

- - 1/4" QUICK CONNECT
- ▭ - 1/4" PIGGYBACK
- ⊞ - FORK CONNECTOR
- - RING CONNECTOR
- ◻ - SOCKET CONNECTOR
- △ - PIN CONNECTOR

33-0027-R2

13-0014A

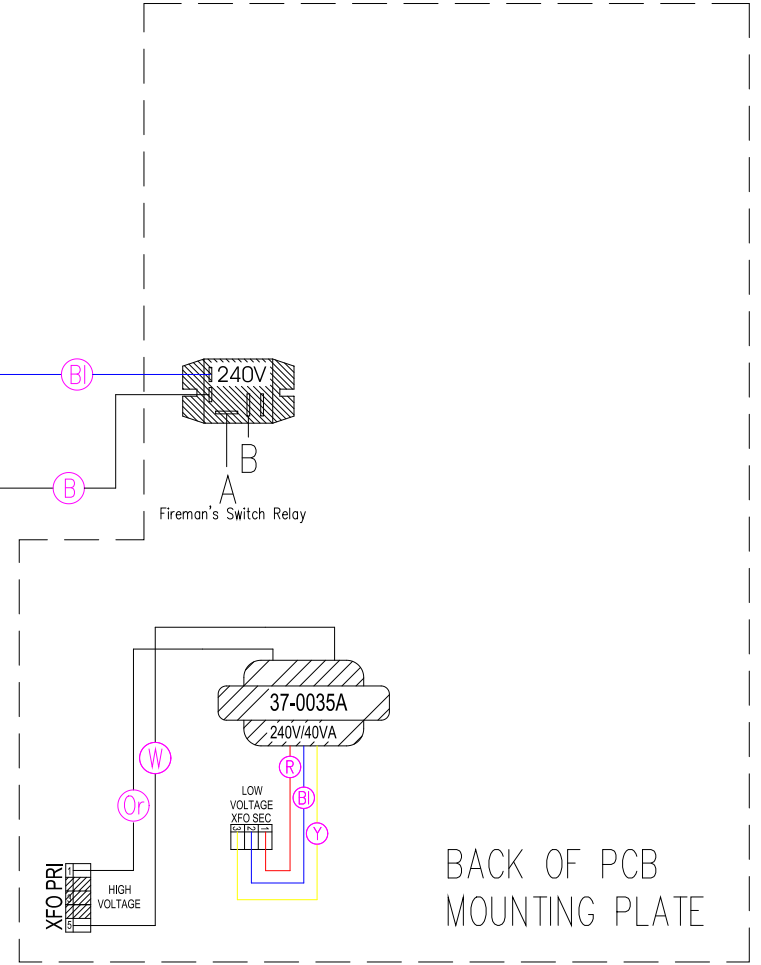
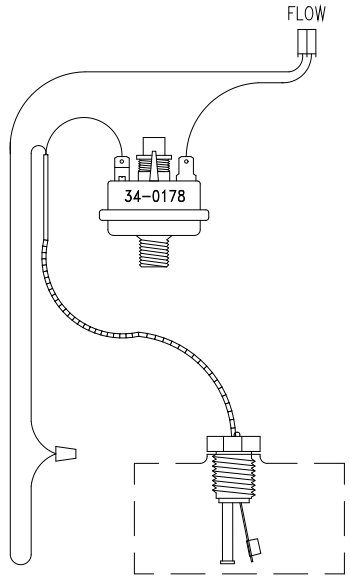
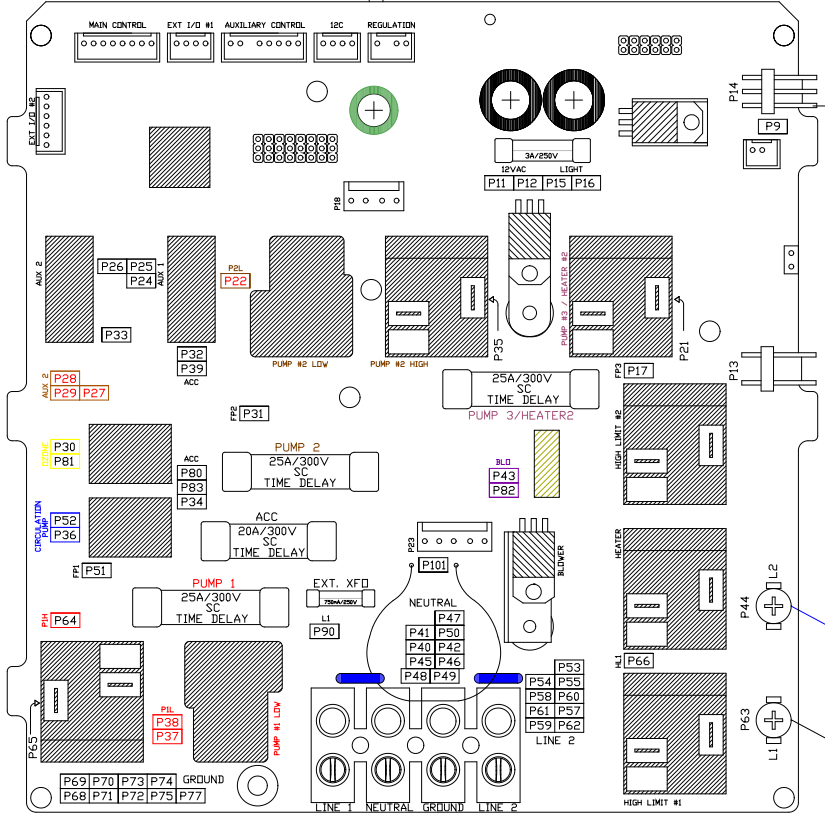

USE COPPER CONDUCTORS ONLY
MAIN INPUT SERVICE
SEE MANUAL

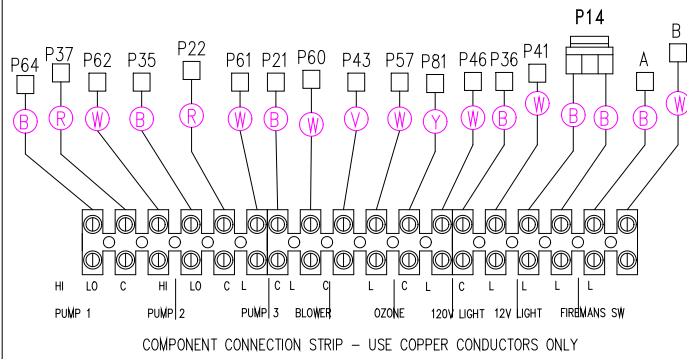

****ALL COMPONENTS MUST BE GROUNDED****

HYDRO-QUIP
 CORONA, CA (951) 273-7575

Manufacture Notes:

Dwg. No.
G822A0-KLPQY-J

Drawn MBS
 Date 08.30.12
 Diagram No. 5150

Rev 06
Wire Color Code
 B - Black G - Green
 Br - Brown Bl - Blue
 R - Red V - Violet
 O - Orange W - White
 Y - Yellow Gr - Gray

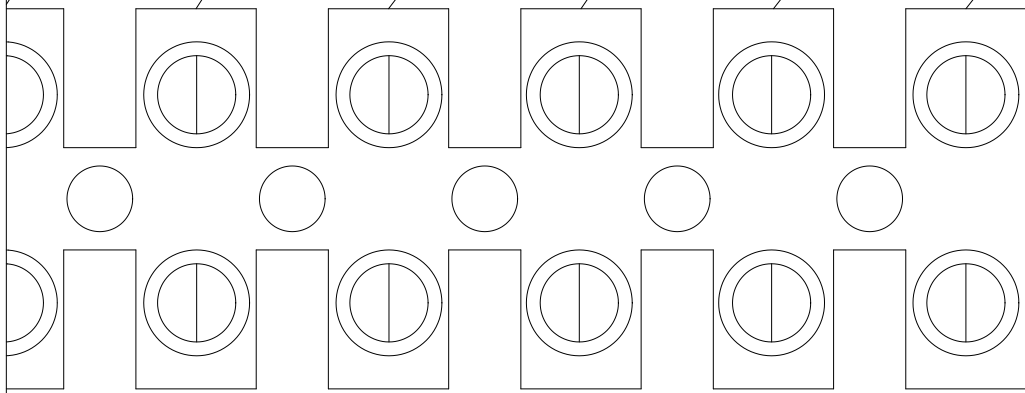
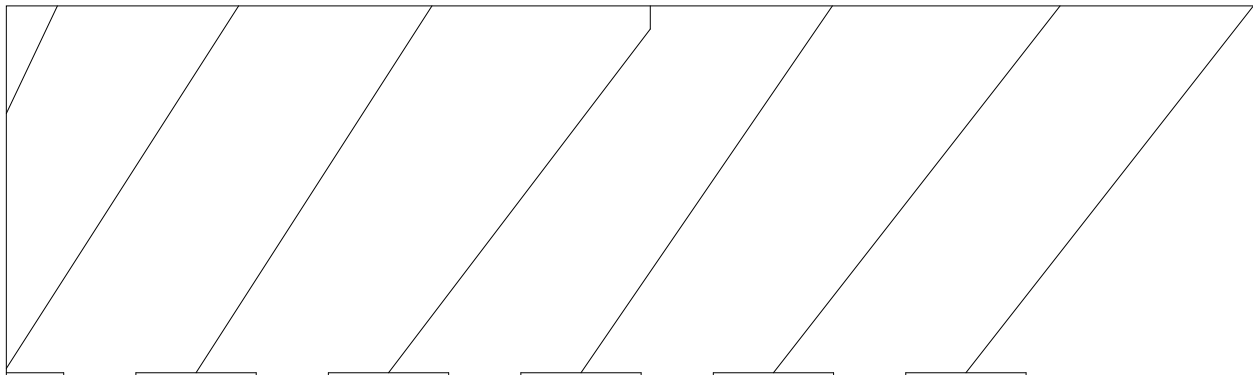

L L L L L

LIGHT 12V LIGHT FIREMANS SW

CONDUCTORS ONLY

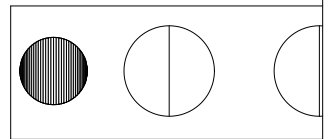

**AL

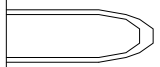

75

Manufacture Notes: