

12V Light (White 2-Pin)

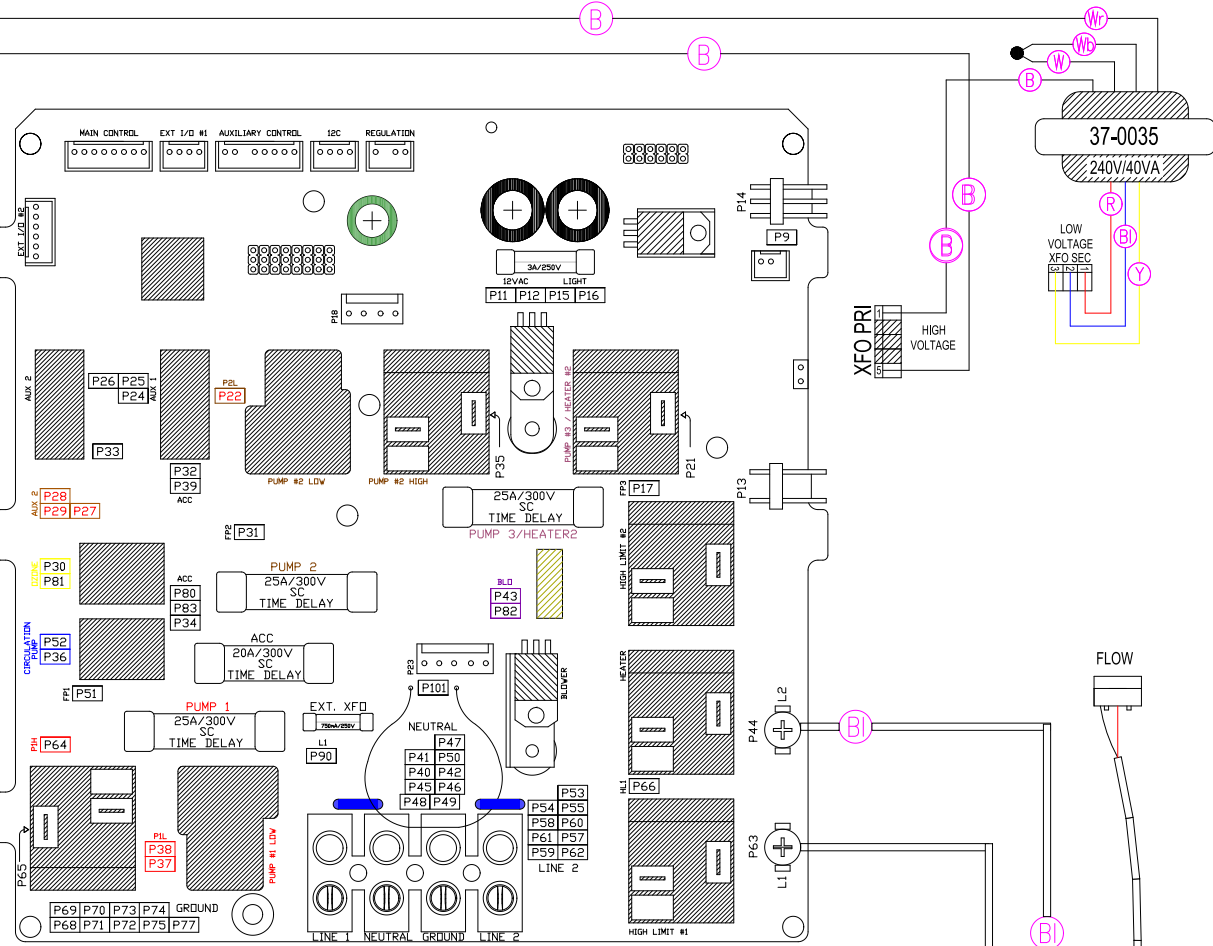

33-0025-R8

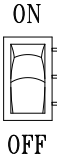
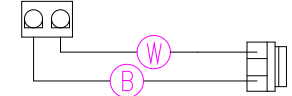
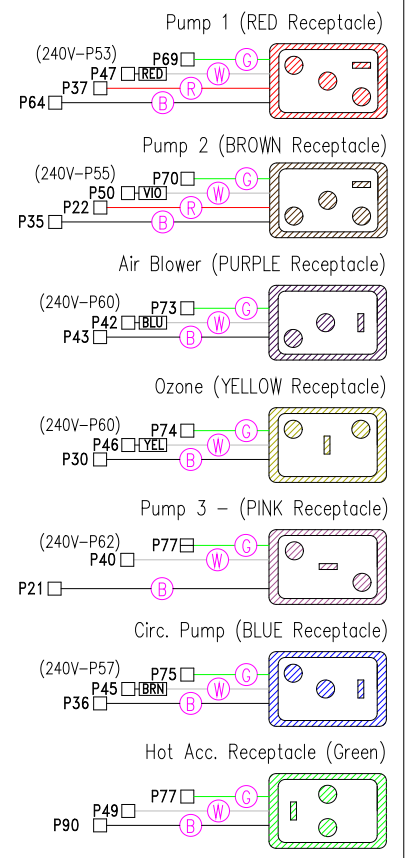
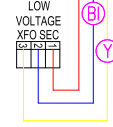
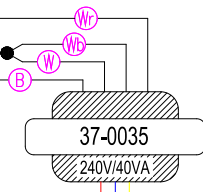
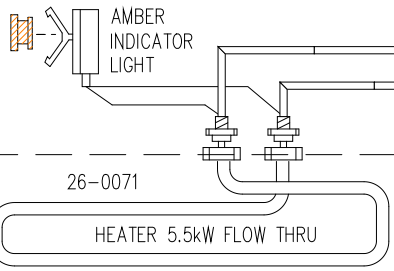

HYDRO-QUIP
CORONA, CA (951) 273-7575

Manufacture Notes: EX: RED - DENOTES THE COLOR OF HEAT SHRINK USED.

For 120V Operation:

Drawn GC	Rev 2	Wire Color Code B - Black G - Green Br - Brown BI - Blue R - Red V - Violet O - Orange W - White Y - Yellow Gr - Gray
Date 06.05.07		
Diagram No. 4431		