

12V Light (White 2-Pin)

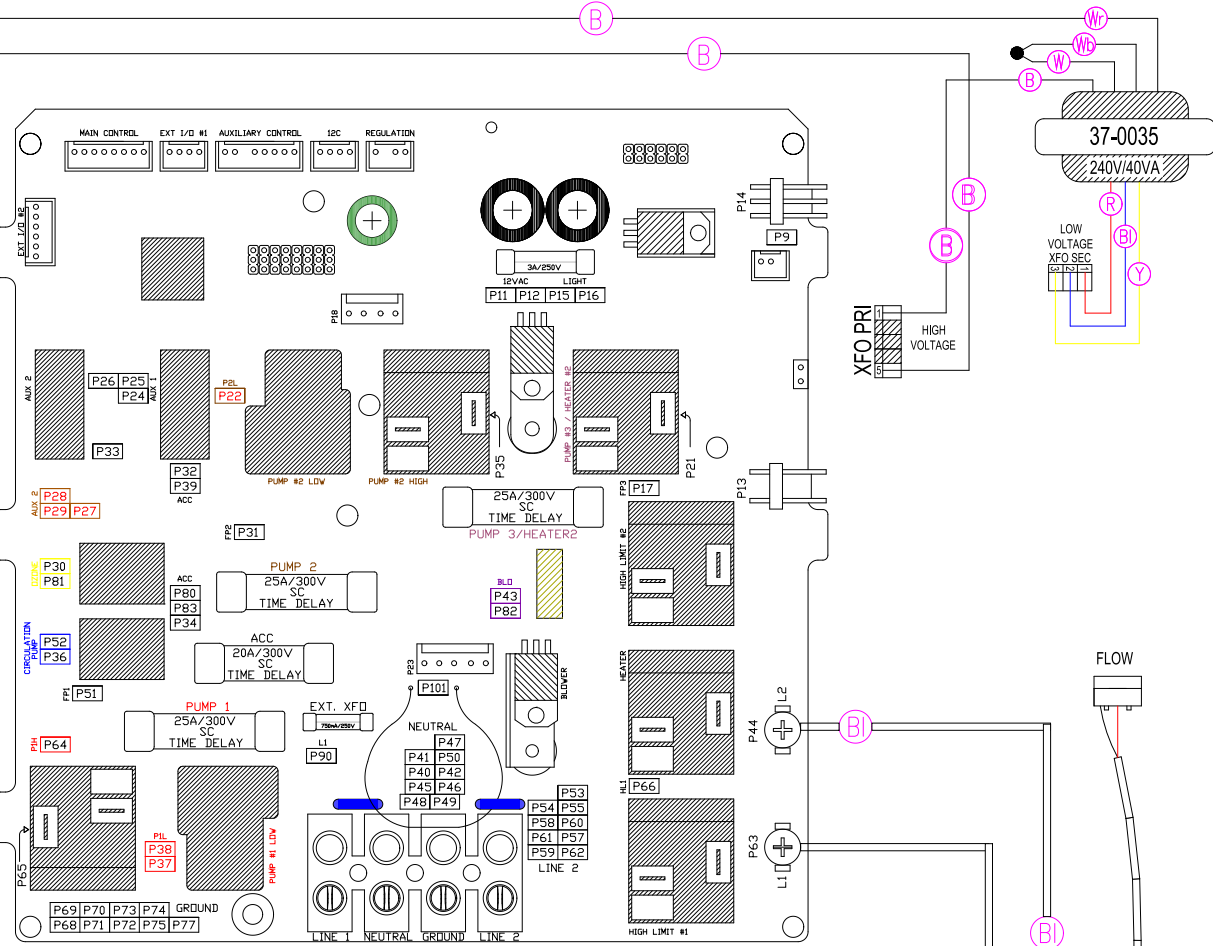

33-0025A-R8

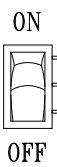
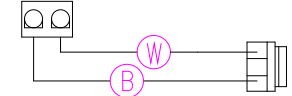
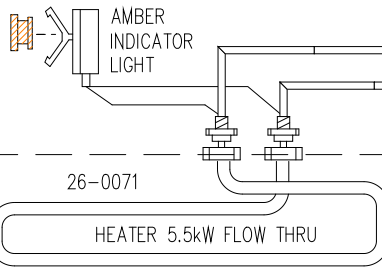
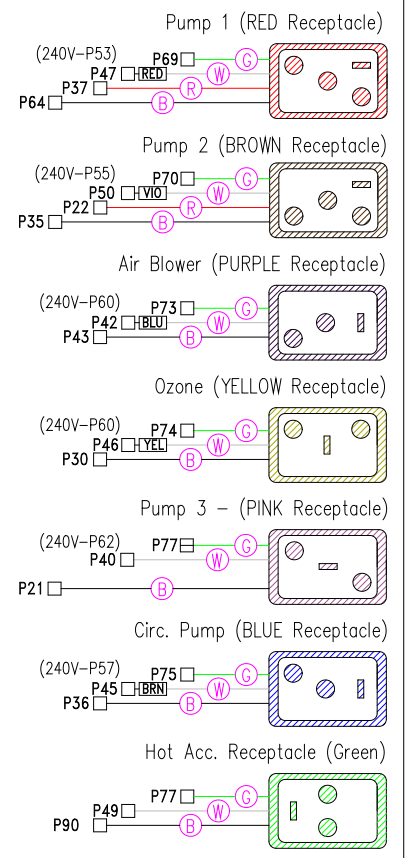
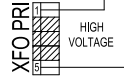
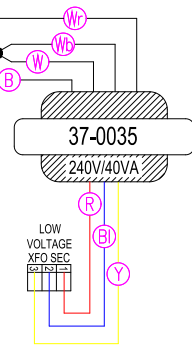

34-0178B  
RED LABEL

**HYDRO-QUIP**  
CORONA, CA (951) 273-7575

Manufacture Notes: EX: RED - DENOTES THE COLOR OF HEAT SHRINK USED.

For 120V Operation:

Drawn GC	Rev 1	Wire Color Code B - Black      G - Green Br - Brown    BI - Blue R - Red        V - Violet O - Orange    W - White Y - Yellow     Gr - Gray
Date 06.15.09		
Diagram No. 4431Z		