

USE COPPER CONDUCTORS ONLY

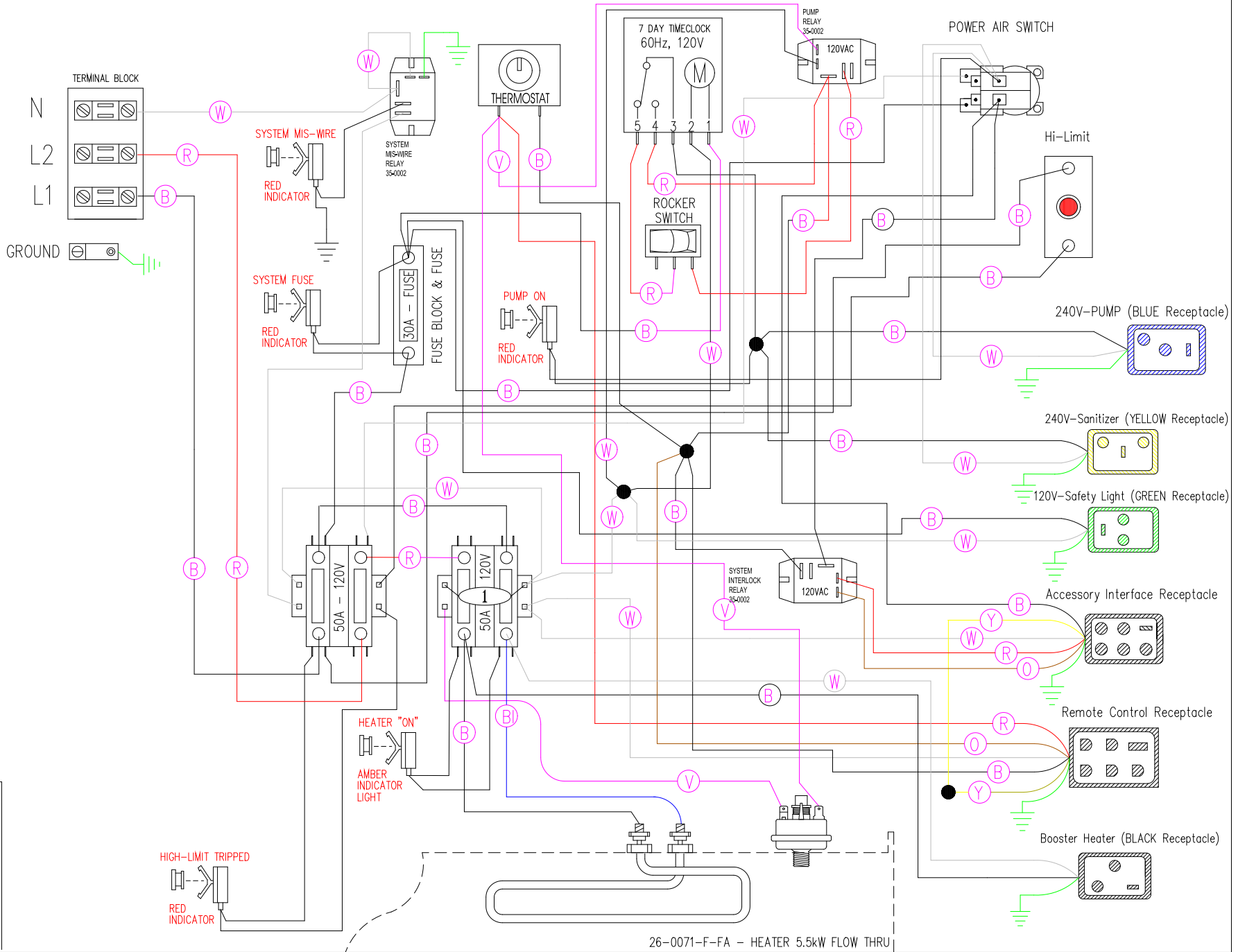

VDS CONFIGURATION

- HEATER "ON"
- PUMP "ON"
- CHECK SYSTEM FUSE
- HIGH-LIMIT TRIPPED
- SYSTEM MIS-WIRE

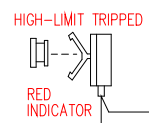

26-0071-F-FA - HEATER 5.5kW FLOW THRU

Manufacture Notes:

Dwg. No. 10000-HKQTY-J	Drawn MO	Rev 03	Wire Color Code B - Black G - Green Br - Brown Bl - Blue R - Red V - Violet O - Orange W - White Y - Yellow Gr - Gray
Date 08.09.16			
Diagram No. 2036			