

USE COPPER CONDUCTORS ONLY

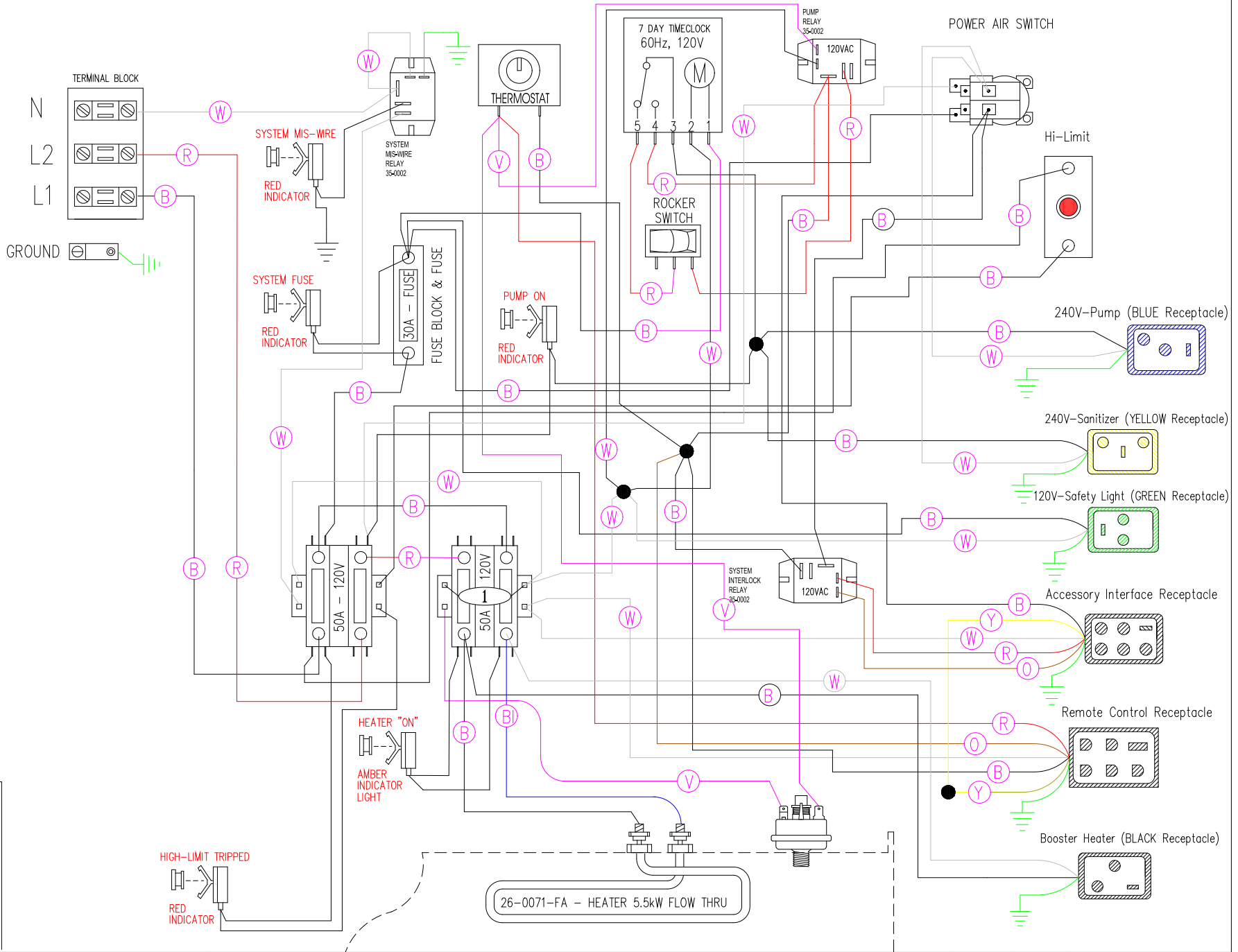

VDS CONFIGURATION

- HEATER "ON"
- PUMP "ON"
- CHECK SYSTEM FUSE
- HIGH-LIMIT TRIPPED
- SYSTEM MIS-WIRE

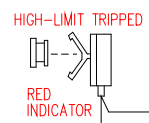

Manufacture Notes:

Dwg. No. 10000-HKQTY-J	Drawn MBS	Rev 02	Wire Color Code B - Black G - Green Br - Brown Bl - Blue R - Red V - Violet O - Orange W - White Y - Yellow Gr - Gray
Date	05.14.15		
Diagram No.	2035		