

USE COPPER CONDUCTORS ONLY

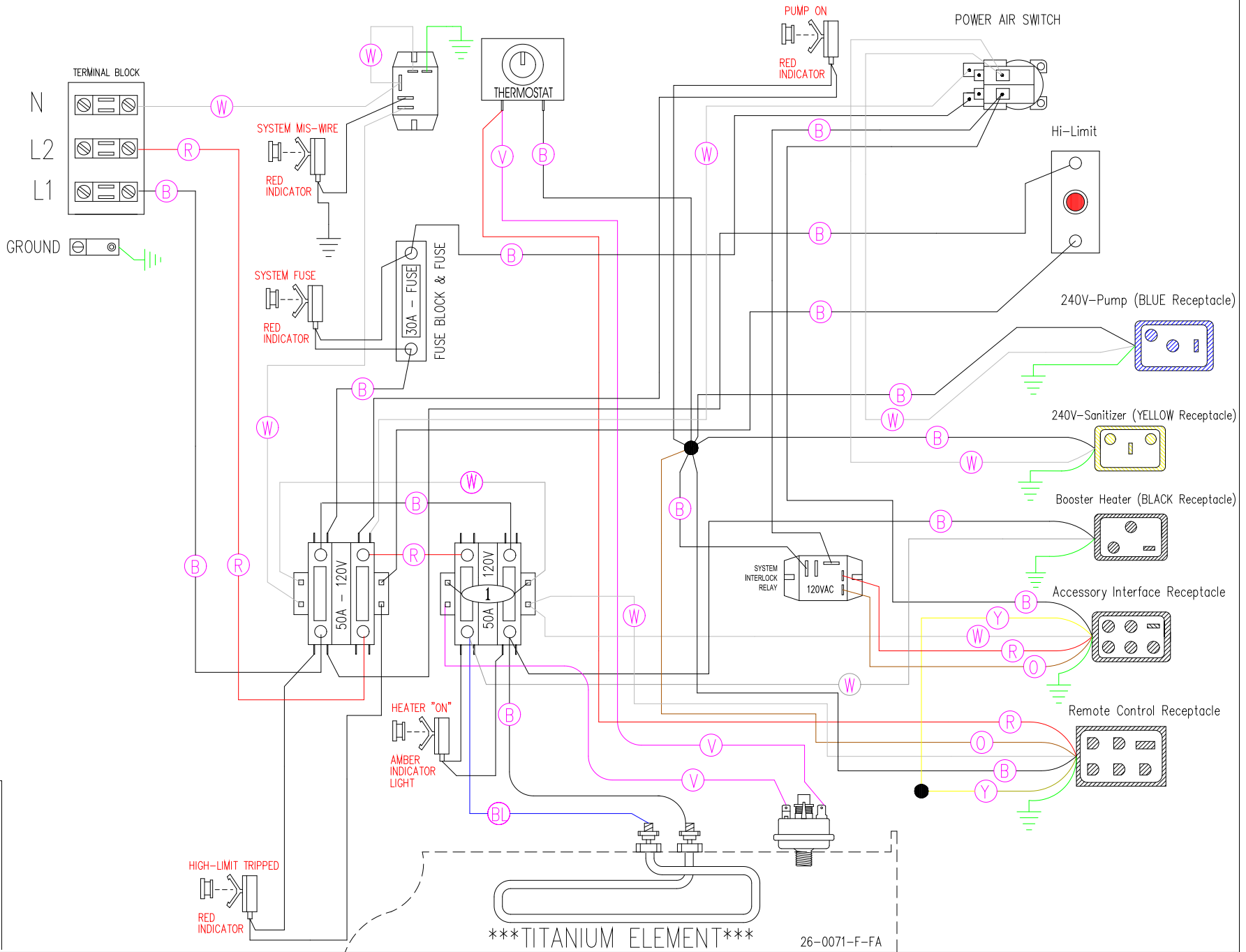

VDS CONFIGURATION

- HEATER "ON"
- PUMP "ON"
- CHECK SYSTEM FUSE
- HIGH-LIMIT TRIPPED
- SYSTEM MIS-WIRE

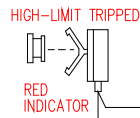

\*\*\*TITANIUM ELEMENT\*\*\*

26-0071-F-FA

Manufacture Notes:

Dwg. No. 10000-HKQTY-J	Drawn MBS	Rev 02	Wire Color Code B - Black    G - Green Br - Brown    Bl - Blue R - Red       V - Violet O - Orange    W - White Y - Yellow    Gr - Gray
Date 08.26.15			
Diagram No. 2027			