

30-0054

16/3 - SJT - 3 FEET

SENSORS TO BE GLUED TO HOUSING AS SHOWN USING THERMAL ADHESIVE

0.125 MIN

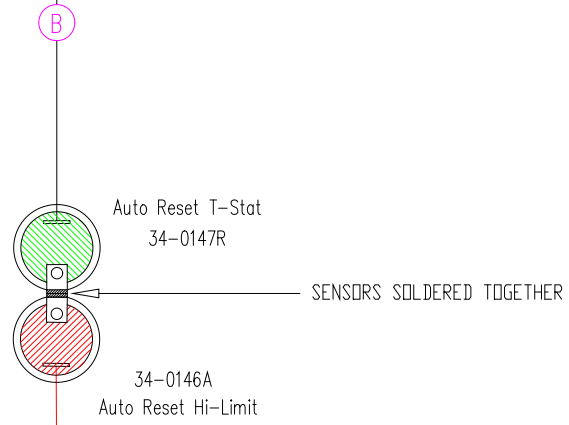
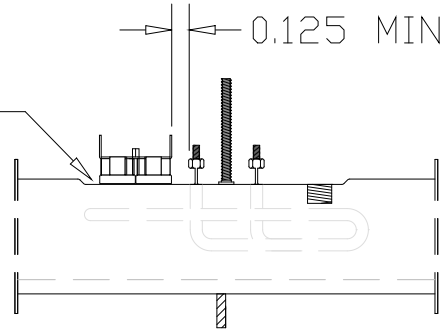
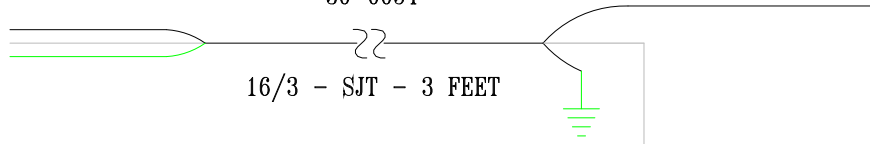

37-0020C
Amber Indicator
Light

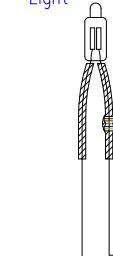

INLINE HEATER
1.5kW @ 120V

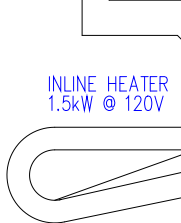

26-0018M-RA

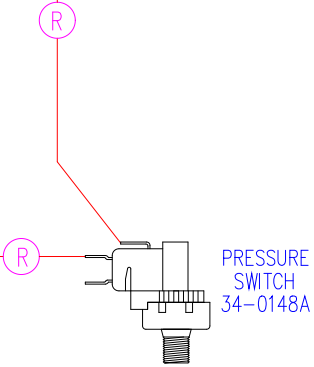

PRESSURE
SWITCH
34-0148A

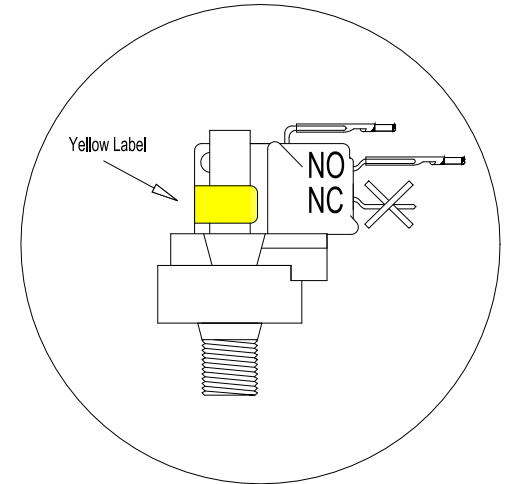

48-32AP-80

15-0110

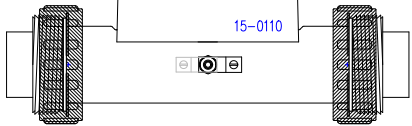

Include Two (2) Ground Lugs on
PURE HEAT, LOWE'S & MAAX Product

Manufacture Notes:

HYDRO-QUIP
CORONA, CA (951) 273-7575

Drawn BH	Rev 02	Wire Color Code	
Date 03.20.08		B - Black	G - Green
Diagram No. 1341		Br - Brown	Bl - Blue
		R - Red	V - Violet
		O - Orange	W - White
		Y - Yellow	Gr - Gray