



Troubleshooting

**The 6220 Series
Spa Controls System**



HYDROQUIP™

THE **SMART** CHOICE™

Contents

Preparing for the Job	2
Tools for Job	
Spare Parts to Bring	
Prior to Service Call	
Getting Started - VDS™ (Visual Diagnostic System)	3
Error Identification - 3 Flashing Dots	4
Error - Pressure Switch Not Activated	5
Error - Pressure Switch Activated	6
Pressure Switch Adjustment	6
Error - Over Temperature	7
Error - Temperature Sensor	8
Freeze Protection	8
Filter Cycle Programming	9
Low Level Programming	10
Circuit Board Layout	11
Nothing Works!	12
GFCI Tripping!	13
No Heat!	14
No Pump 1!	14
No Pump 2!	15
No Ozone!	15
No Spa Light!	16
No Spaside Control!	16

Preparing for the Job

This Troubleshooting Manual has been designed for easy simple step-by-step problem solving and fault isolation.

It is important to identify all of the possible causes of the problem before making a final diagnosis. What you see at first is usually a symptom of the problem, not necessarily the problem itself.

Read the entire troubleshooting procedure related to what you are testing for prior to performing the test. This will give you a clearer overall view and help to avoid a mis-diagnosis.

Prepare for the service call. Make sure you have the right tools.

Tools for the Job:

- Multi-Meter and Clamp-On Ammeter
- Jumper Cable
- Accurate Thermometer
- Standard & Philips Screwdrivers
- 1/4 in. & 3/8 in. Open-End Wrench
- 11/32 in. Nut Driver
- GFCI Tester (optional)



Spare Parts to Bring:

- Spaside Control
- Temperature Sensor
- High-Limit Sensor
- Fuses
- Printed Circuit Board

Prior to the service call, have the homeowner check the following:

- Make sure spa has been filled to the water level suggested by the spa manufacturer.
- Insure that all water shutoff valves are open and are not vibrating closed.
- Adjust diverter valves and/or jets to allow adequate back pressure to heater assembly.
- If 3 flashing dots appear on the spaside control display:
- Have the homeowner remove the filter and operate system. If the error goes away, a filter cleaning is required. The filter may not look dirty, we are dealing with oils, lotions etc... Use an appropriate filter-cleaning agent.
- Get data label information off of the spa control.

Getting Started - VDS (Visual Diagnostic System)

Equipped with exclusive VDS™ (Visual Diagnostic System) by Hydro-Quip, Troubleshooting can be done at glance. Once the spas equipment compartment has been accessed, check to see if a VDS indicator has been illuminated. The description of that indicators function is printed on the faceplate. Simply go to that section and start from there.

With VDS you can see if a fuse has blown, check incoming power (optional) and verify that the heater has been activated. If equipped with our exclusive line of lighted cords, you can verify component power supply (single or dual speed). Other optional features include externally mounted fuses.

System circuitry may vary and some options may not have been included with the particular control you are servicing.

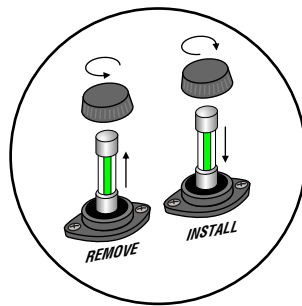

WARNING - Remove power prior to changing a fuse.

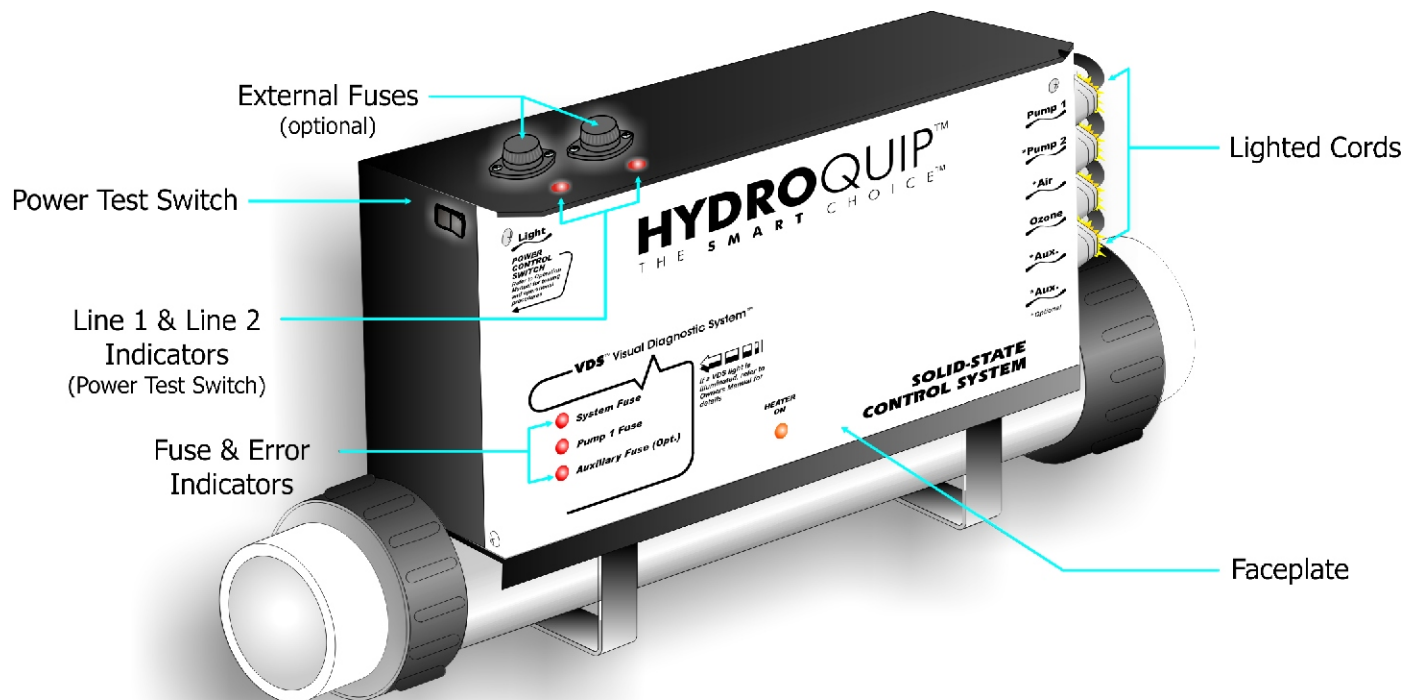

Error Identification - 3 Flashing Dots

"3 Flashing Dots" indicate a system error has occurred. Possible causes for this error will be:

A) - the system has started (low speed pump) but the pressure switch has not closed. The heater will not activate, pressure switch adjustment may be necessary.

B) - the system has not yet been started but the pressure switch is closed. The heater will not activate, pressure switch adjustment may be necessary.

C) - there has been a "High-Temperature" condition detected. "3 flashing dots" with the "High-Limit" indicator illuminated on the system circuit board lets you know the spa water temperature has been/or is currently above the normal usage parameters. To properly identify which, perform the following tests:

- **Turn the pump(s) off manually by pressing the Down Arrow key to lower the temperature to its lowest setting or by pressing the Pump 1 (and/or Pump 2) key. There is a 20-second cool down cycle once the heater has been turned off, so the pump will continue to run until this cycle has ended.**
- If the "3 Flashing Dots" went away, the pressure switch was open (not activated) even though water was flowing through the heater. **Refer to page 5 for details.**
- If the "3 Flashing Dots" are still present, the pressure switch is closed (activated) though there is no water flowing through the heater. **Refer to page 6 for details.**
- If the "High-Limit" indicator is illuminated on the system circuit board, **Refer to page 7 for details.**

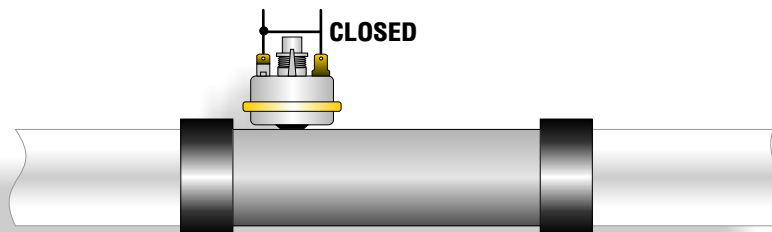
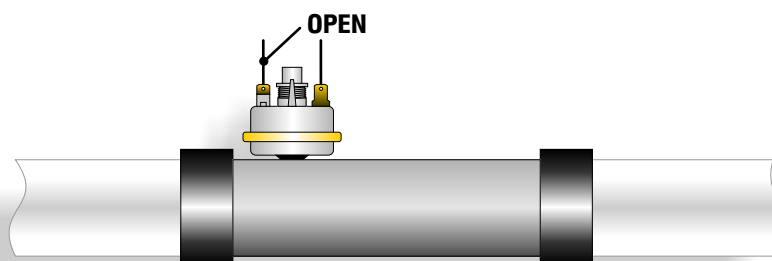

Error - Pressure Switch Not Activated

With the pump(s) operating properly and "3 Flashing Dots" showing on the spaside control you've narrowed the problem down to the pressure switch. Perform the following tests to be sure that you have properly diagnosed the problem:

Note: There must be enough water in the spa for normal use. This error can also be caused by a restricted flow of water caused by debris caught in the plumbing. The heater will not activate while this error is displayed.

- Verify that the pump(s) is functioning properly. If the pump(s) is not functioning properly, refer to the Pump section that applies.
- Remove the filter and operate as normal. If the error clears, the filter is dirty and requires cleaning. Also check for air locks, closed valves or anything that would restrict the flow of water.
- Check the pressure switch cord connections at the system circuit board as well as at the pressure switch. Check for proper pin to connector alignment and security.
- If you've verified that the pump(s) is functioning properly, the filter is not dirty, water shutoff valves are open, there is no debris in the plumbing causing a restricted flow of water and that all connections are secure, the pressure switch requires adjustment. **Refer to page 6 for pressure switch adjustment.**

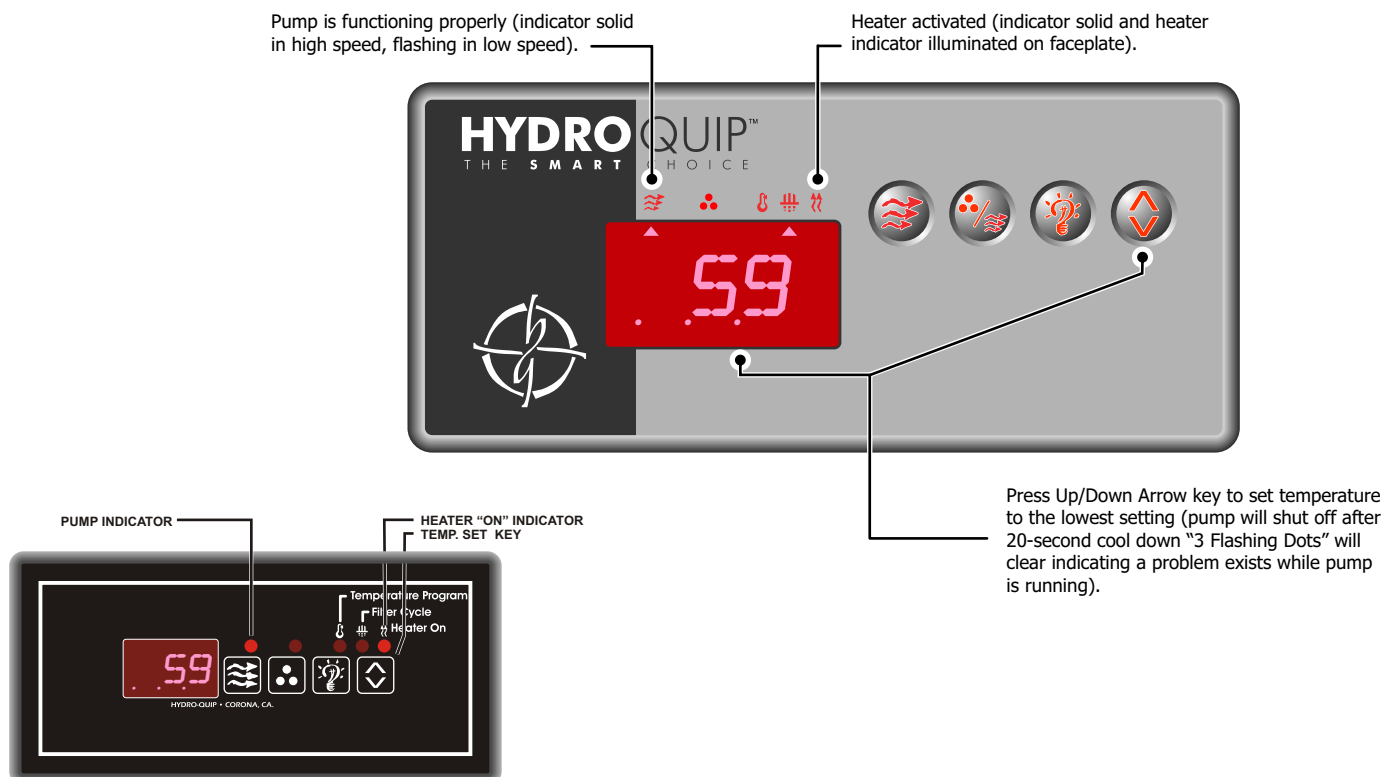

Error - Pressure Switch Activated

With the pump(s) turned off and "3 Flashing Dots" showing on the spaside control you've narrowed the problem down to the pressure switch. Perform the following tests to be sure that you have properly diagnosed the problem:

Note: There must be enough water in the spa for normal use. The heater will not activate while this error is displayed.

- Disconnect the pressure switch cord at the printed circuit board connection, if the "3 Flashing Dots" do not go away replace the printed circuit board.

Pressure Switch Adjustment

If your system is equipped with a pressure switch, the function of the pressure switch is to turn the heater off if the pump stops operating or if there is restricted water flow (dirty filter, obstruction in the spa plumbing etc.).

The pressure switch has been preset at the factory to operate properly with your spas specific plumbing. Adjustment or other service may be required if you observe a flow related problem (3 flashing dots on spaside display). If adjustment is required, follow the next steps carefully.

IMPORTANT: After any pressure switch adjustment, it is important to test the control by turning on the pump low speed and heater. While operating, unplug the pump, the heater must turn off. If the heater stays on, plug the pump back in and readjust the pressure switch to achieve proper operation.

- 1) With power to system turned OFF, remove the wires from the pressure switch terminals (secure wires safely to prevent any chance of electrical shock).
- 2) Turn power to the system ON. If system automatically starts in low speed, press Down Arrow key to set temperature to its lowest setting (pump will turn off after cool down cycle).
- 3) Place an Ohmmeter across the pressure switch terminals to verify an OPEN circuit.
- 4) Rotate the pressure switch adjustment screw counter-clockwise until the Ohmmeter indicates an CLOSED circuit.
- 5) Then rotate the pressure switch adjustment screw clockwise until the Ohmmeter indicates an OPEN circuit again.
- 6) Turn power to the system OFF and reconnect pressure switch terminals. Reapply power to the system and resume normal operation.

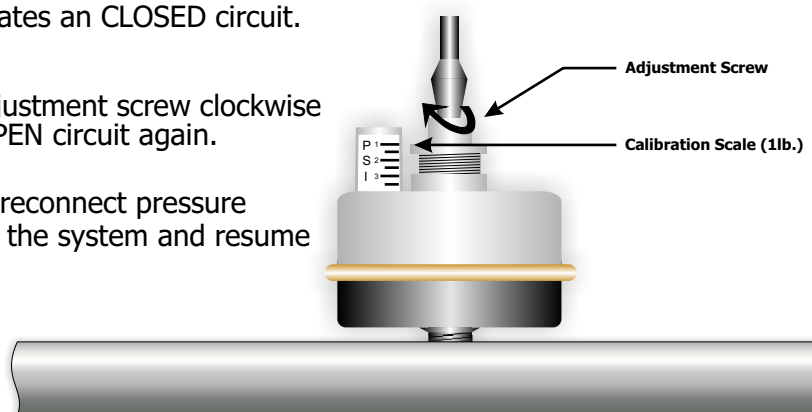

Error - Over Temperature

If "3 Flashing Dots" appear in the spaside display window, and the High-Limit indicator is illuminated on the system circuit board, an overheat condition has been detected. It is not safe to enter the spa until this error has been corrected.

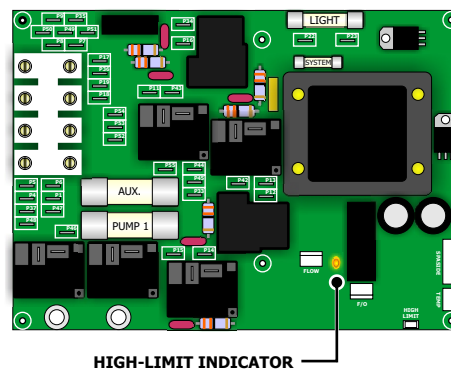
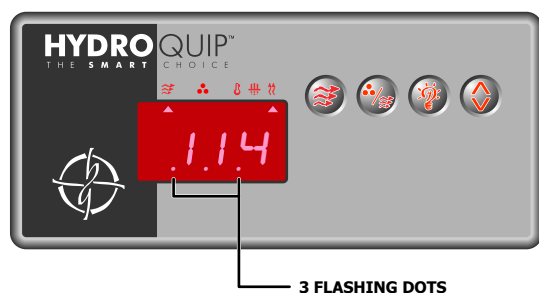

If the water temperature exceeds 112°F at the systems temperature sensor (located in a plumbing dry-well or in wet-well in the spa) the system will shut off the heater and all other outputs will be disabled (pump(s), blower etc.) until the water temperature drops below 110°F.

If the water temperature exceeds 119°F at the systems high-limit sensor (clamped to the stainless steel heater assembly) the system will shut off the heater only until the water temperature drops below 110°F. The pump(s), blower and other outputs will stay active.

- Carefully check the heater housing first to see if it is hot to the touch. If it is there may be an obstruction in the plumbing, a dirty filter or closed water shutoff valve. **Power must be cycled off then back on for the system to reset this error.**
- Check the water temperature with an accurate thermometer. If the temperature displayed on the spaside control greatly differs, the temperature sensor may not be fully inserted into the wet-well or may be defective. Inspect the sensor's circuit board connection (straighten and/or clean pins if needed). If this does not correct the problem, replace the sensor. (Remember to reset power to clear the error)
- It may be necessary to insulate around a temperature or high-limit sensor that is being adversely affected by the ambient (outside) temperature.
- If the weather is extremely hot, remove the spa cover. Running the blower may help cool the water. Add cold water if necessary. (Remember to reset power once the water has cooled)
- Lower the systems set temperature by pressing the Up/Down Arrow key, the "Heater On" indicator should go out. If the indicator stays on, replace the system circuit board.

Error - Over Temperature (cont.)

- If the "Heater On" indicator did in fact go out, the pump may be overheating the spa. Lower the duration of the filter cycle as follows:

Press and hold the Light key for 5-seconds, the current filter cycle duration will appear. Use the Down Arrow key to lower the duration of the filter cycle. Once the setting has been sufficiently lowered, press the Light key to confirm the change. The display will then revert back to the standard Temperature display.

Error - Temperature Sensor

If the spaside display shows a constant 32°F or 122°F, the temperature sensor has failed. Check the sensors circuit board connection (clean or straighten pins if necessary). If the problem is not resolved the temperature sensor must be replaced. If the problem persists, replace the system circuit board.

Freeze Protection

The system is constantly monitoring the temperature, high-limit and onboard (circuit board mounted) sensors. If the onboard sensor registers an ambient temperature below 59°F, the systems "Smart Winter Mode" will activate. This mode, once activated, will continue for a period of 24-hours. The system will activate any pump connected to the system, that has not been turned on in the last 2-hours, for 1-minute to prevent freezing. The frequency of this cycle may increase as the ambient temperature drops.

During the "Smart Winter Mode" the filter cycle indicator  will flash while the pump(s) is running in this mode.

If the customers complaint is that the spa is running every 2-hours as if it has a mind of its own, it does and in colder weather this is a safety feature designed to protect the spa.

Filter Cycle Programming

Throughout the troubleshooting process it may be necessary to alter the filter cycle duration. The following steps will walk you through the setup:

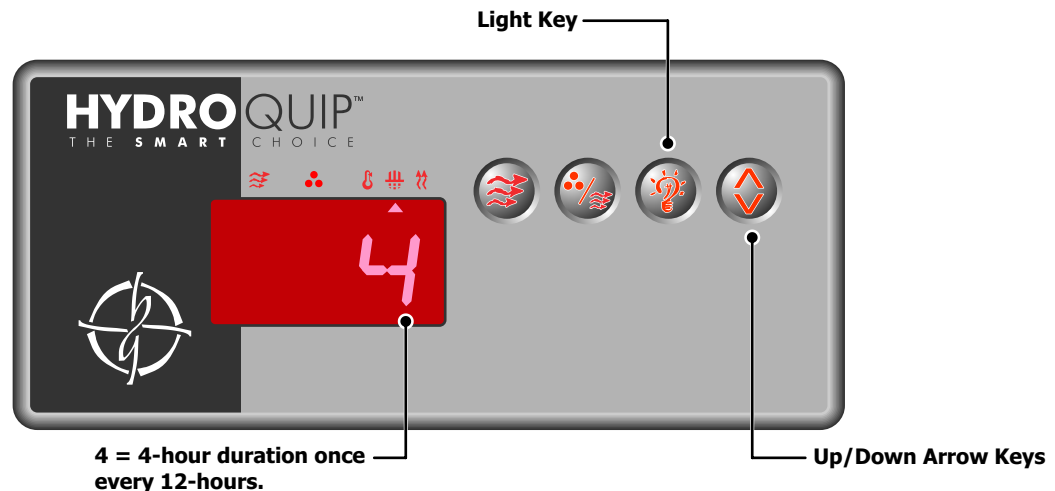

Programming Filter Cycles: You may choose to filter the spa 1, 2 or 3 times per day as required to keep the water clean and sanitary. Press and hold the Pump Key. The current setting will be displayed. Press and hold the Temperature Set Key to increase or decrease the frequency of the filtration cycles per day. The filter cycle is now set. The cycles will repeat every 8, 12 or 24 hours within a 24-hour period starting from the time programmed. It is recommended to schedule the filtration cycles so they do not interfere with sleeping hours.

Programming Filter Cycle Duration: You may choose to filter your spa 60, 120, 180 or 480 minutes per cycle as required to keep the water clean and sanitary. Press and hold the Light key. The current duration of the filter cycle will be displayed. Press and hold the Temperature Set key to increase or decrease the duration of the filter cycle. The duration is now set. To start a filter cycle immediately, press and hold the Light key.

Note: If a key is not pressed within 5 seconds during programming, the system will revert back to the monitoring mode. If the Pump and/or light were turned on during the programming process, turn them off. The system will revert back to display the water temperature within 5 seconds.

Power Loss: Any interruption of power will cause the unit to reset and revert to the default programming of 95°F set point temperature and 2, 2-hour filtration cycles.

To prevent overheating of the spa water, the filtration cycle will be suspended any time the temperature reaches 2°F above the set temperature. If the spa water cools to 1°F above the set temperature while the filtration cycle is still active (filter indicator flashing) the filtration cycle will reactivate. The filtration cycle will be suspended if the user enters the spa and activates a pump or blower manually. This is to prevent unnecessary operation of the ozonator. The cycle will be suspended for 40 minutes beyond the last manual activation of any accessory. The filter indicator will flash on the display while the filter cycle is suspended.

Low Level Programming

The Low Level settings such as High Current (limiting heater activation for 120V systems), Temperature Display (Fahrenheit or Celsius) and One or Two Pump operation can all be adjusted via the Low Level Programming jumpers (located on the system circuit board next to the spaside control connection). By simply moving the jumpers from position 1 to position 2 you can set these parameters. Power to the system must be turned off, then back on before the changes can take effect.

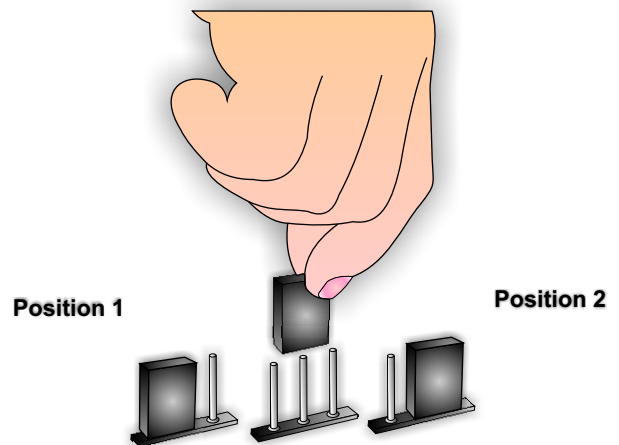
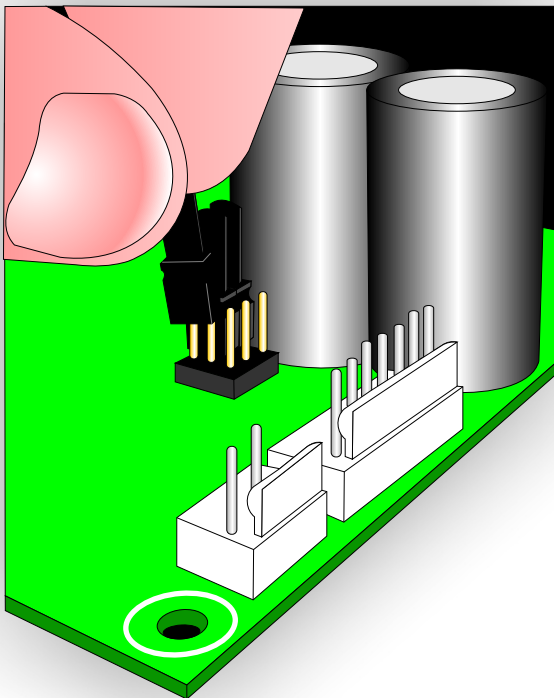

JUMPER 1 = Current Limiting:

Position 1 - (High Current 240vac): There is no current restriction. This allows the heater to operate with the pump in high speed.

Position 2 - (Low Current 120vac): The system will not turn the heater on when Pump 1 is in high speed and/or when Pump 2 or Air Blower are activated. The heater indicator will flash on the spaside to tell the user that there is a call for heat but the heater is not allowed to start.

JUMPER 2 = Temperature Display:

Position 1 - Fahrenheit Degrees

Position 2 - Celsius Degrees

JUMPER 3 = One or Two Pump Operation:

Position 1 - One pump operation

Position 2 - Two pump operation (Standard factory setting)

Circuit Board Layout

Throughout the troubleshooting process you will need to refer to this layout as a reference. To troubleshoot Universal Systems it is important to note that the neutral (white wire w/color coded connector) will ultimately determine that circuit's voltage. Always consult the system wiring diagram included with each control (located on the inside faceplate).

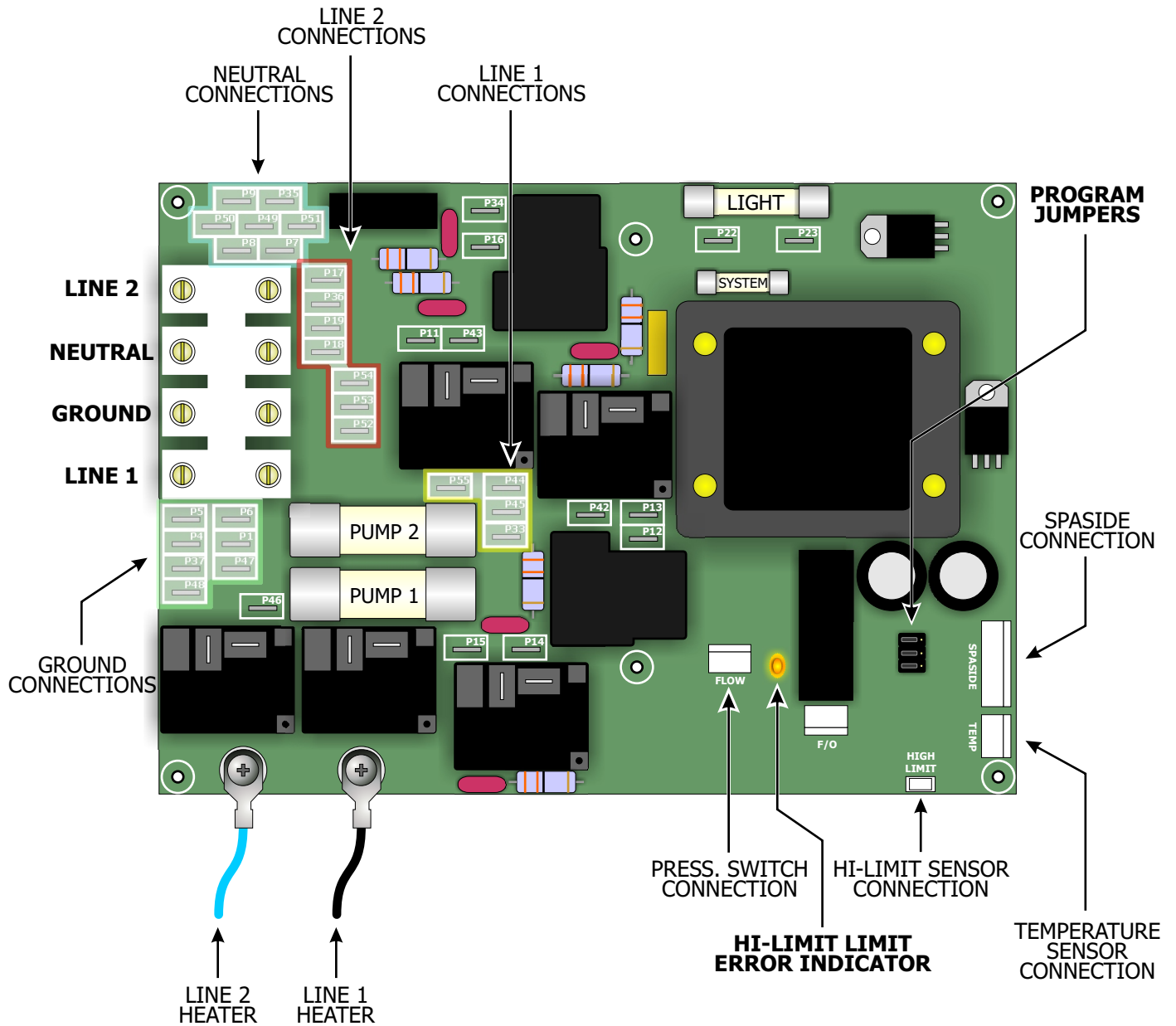

Nothing Works!

The following troubleshooting tree has been designed as a guideline to assist the technician with a quick diagnosis of the problem.

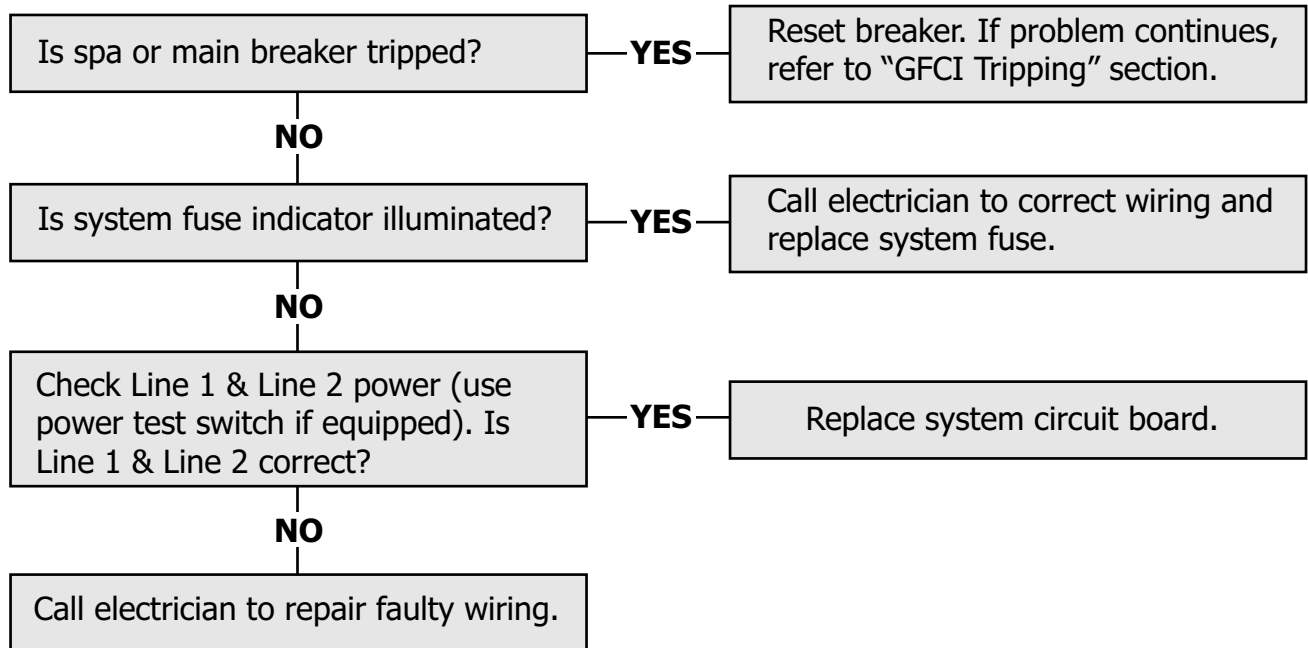

Power Test Switch and Indicators



For systems that do not include a "Power Test Switch", a voltage reading will need to be taken to confirm proper input power.

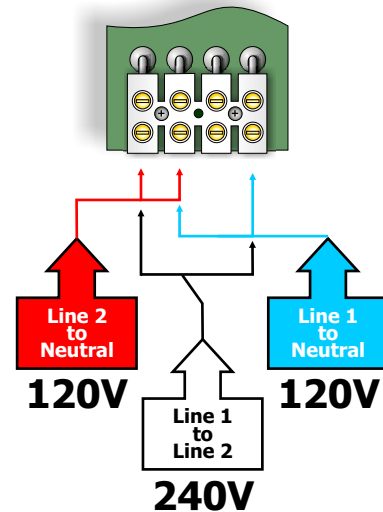

*** Remove power to system prior to accessing the internal control wiring or before changing fuses.**

GFCI Tripping!

When a GFCI circuit breaker is used in the installation of your spa, it is important that it has been properly installed. Often this component has been improperly installed causing the breaker to trip the instant the system is turned on. Below is an illustration of a typical GFCI breaker installation.

WARNING: Refer to Circuit Breaker Manufacturers installation instructions. This illustration is meant to be a guide for Field Technicians and is not intended to override or substitute the instructions supplied with the circuit breaker.

TYPICAL INSTALLATION

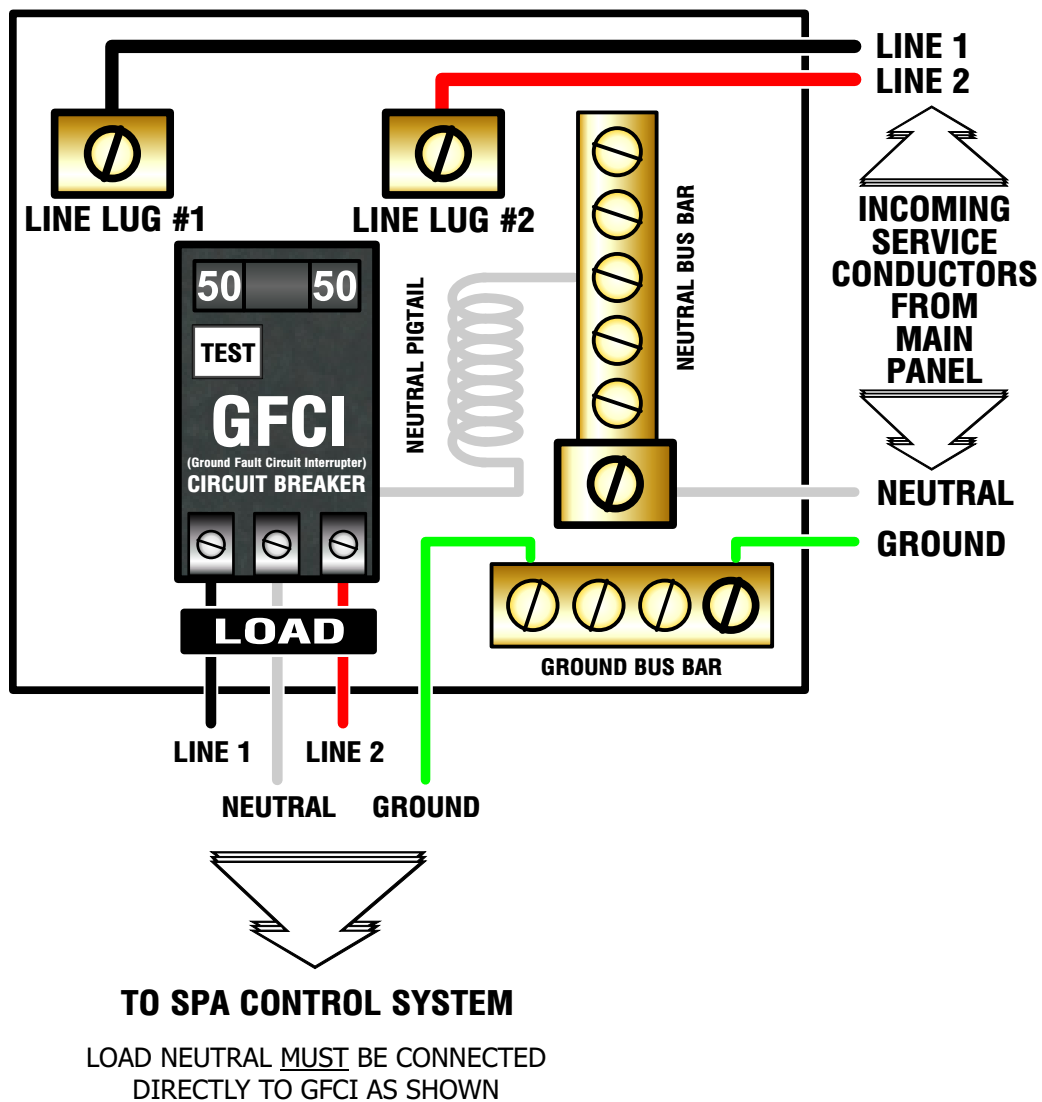

No Heat!

Press the Up/Down Arrow key and increase the temperature to its highest setting. Verify that the heater indicator on the spaside control is illuminated.

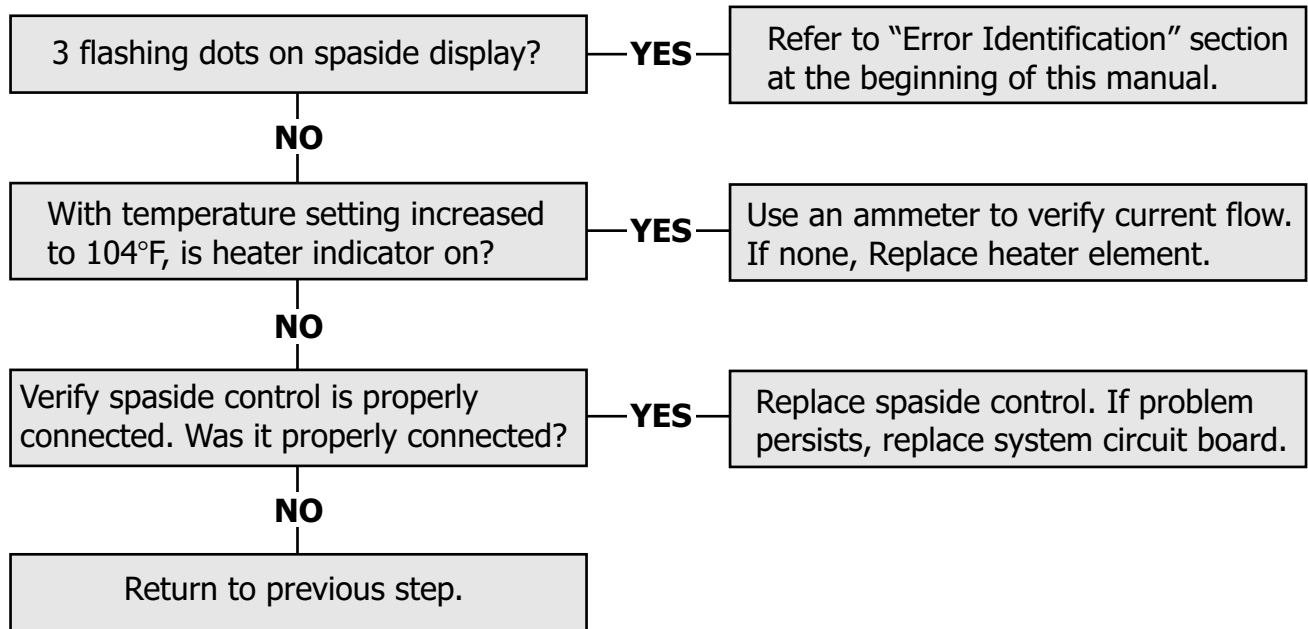

No Pump 1!

The Ozonator is protected by the Pump 1 fuse. Keep this in mind when troubleshooting the Pump 1 circuit. Remember to unplug Ozonator to isolate Pump 1. Press Pump 1 key, verify the Pump 1 indicator is illuminated on spaside control.

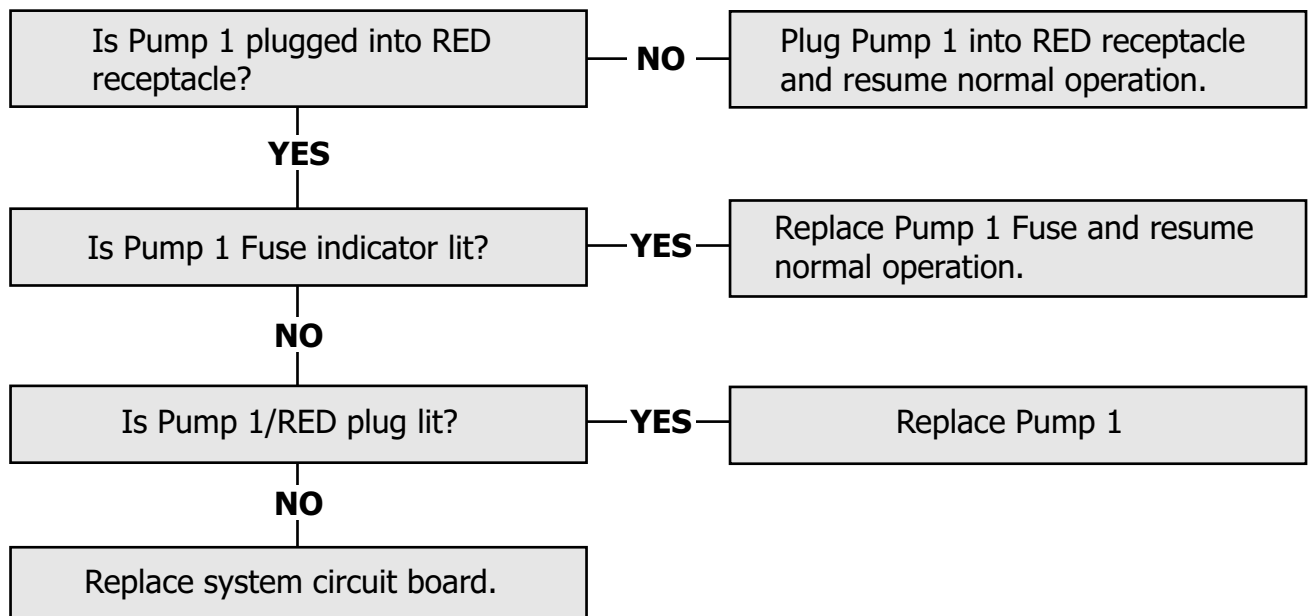

No Pump 2 !

The Pump 2 is also protected by a fuse. Keep this in mind when troubleshooting the Pump 2 circuit. Press the Pump 2 key, verify the Pump 2 indicator is illuminated on spaside control.

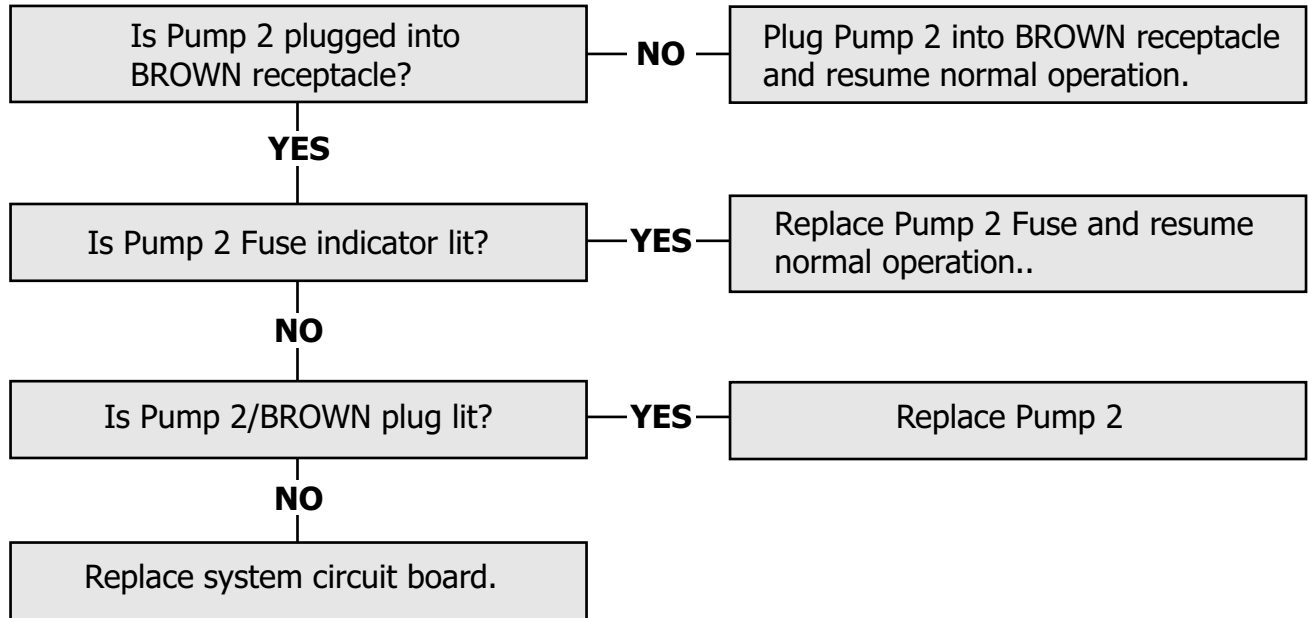

No Ozone!

IMPORTANT - A filter cycle MUST be active before the Ozonator will operate. Refer to "Filter Cycle Programming" to activate a filter cycle prior to troubleshooting the Ozone circuit. The Ozonator is also protected by the Pump 1 fuse. Keep this in mind when troubleshooting the Ozone circuit.

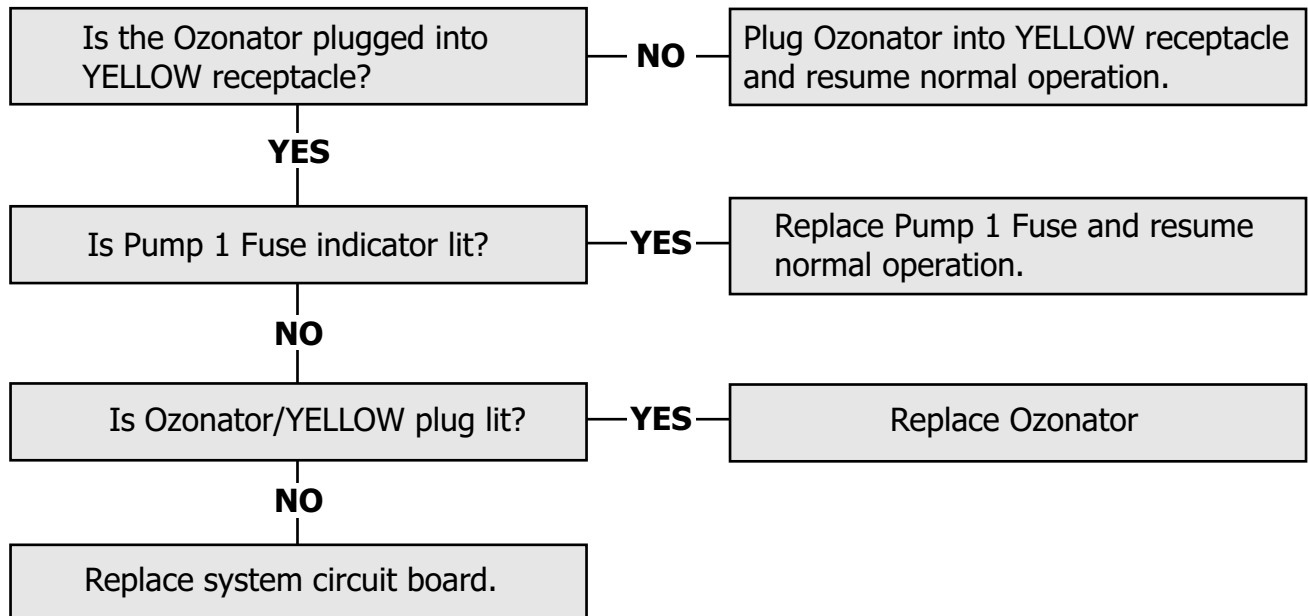

No Spa Light!

The spa Light circuit is protected by its own fuse, with no diagnostic light.

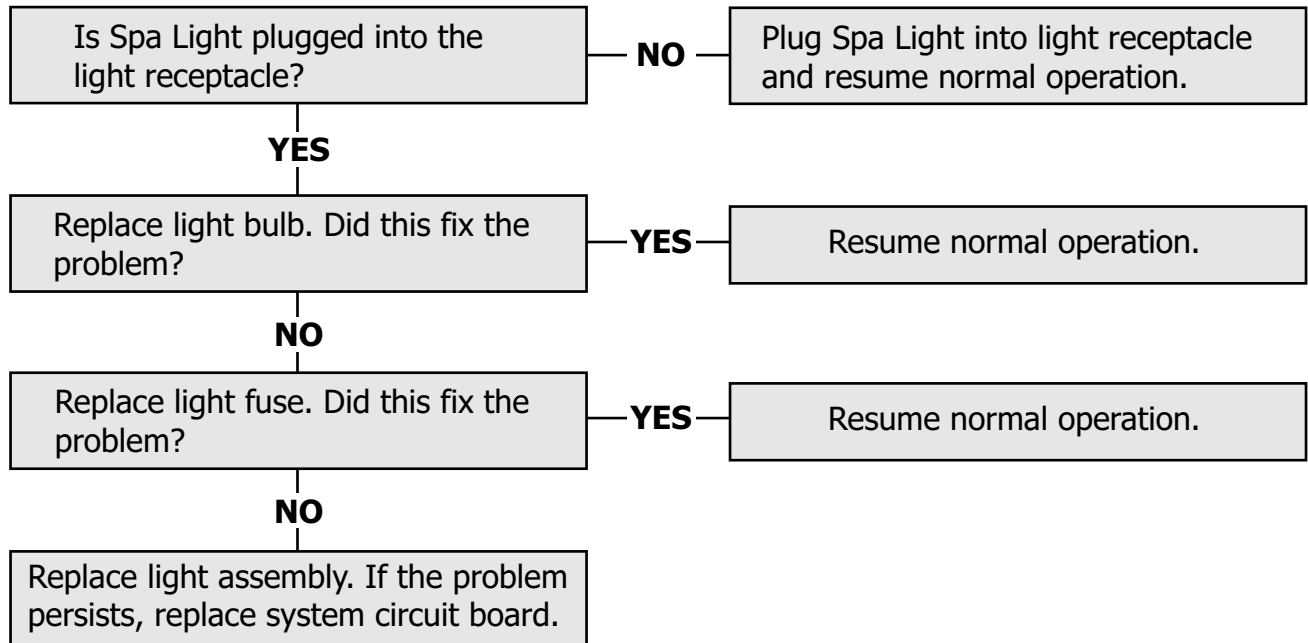

No Spaside Control!

The Spaside Control rarely fails. Verify proper input power prior to troubleshooting.

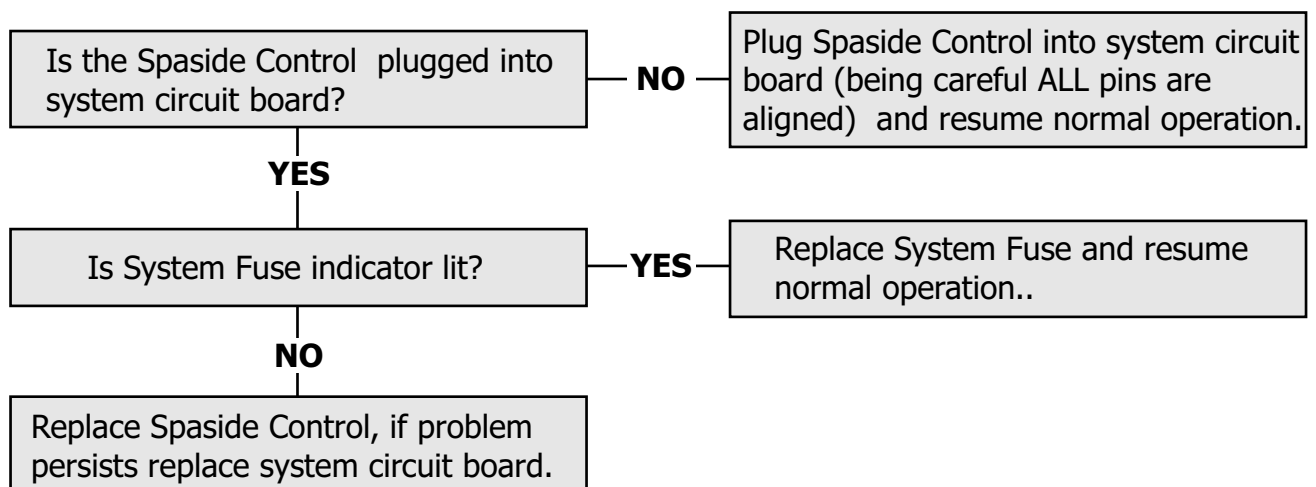



HYDROQUIP™

13345 Estelle Street • Corona, CA 92879-1881

Email: hq@hydroquip.com • Internet: <http://www.hydroquip.com/>

Telephone: 909.273.7575 • Fax: 800.332.7190



For more information, contact our knowledgeable Technical Support team.
Open: 8:00am to 5:00pm Mon-Fri at 909.273.7575