

# HYDROQUIP™

THE **SMART CHOICE**™

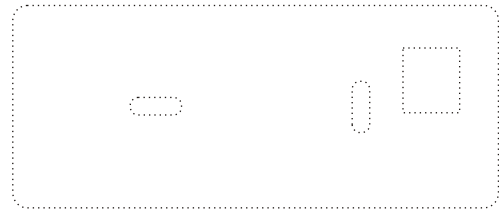

## IN-HOUSE CONTROL INSTRUCTIONS

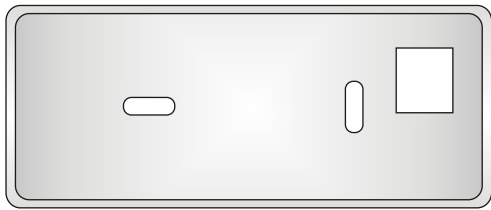
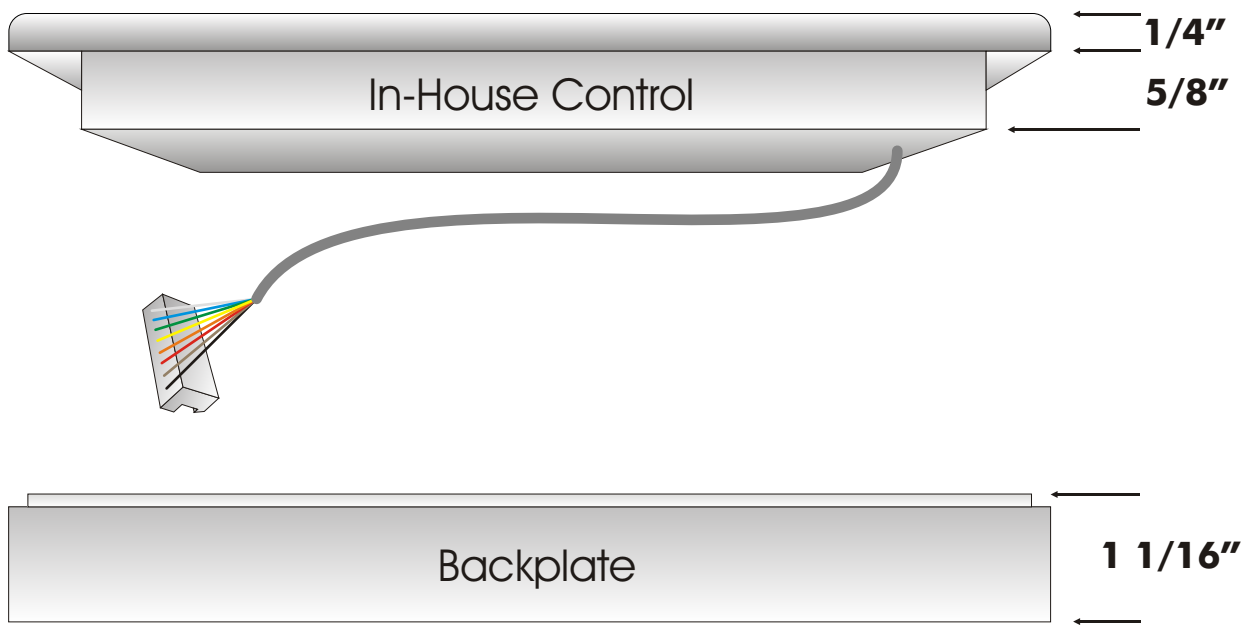

**1** Using the backplate as a template, mark openings with a pencil.

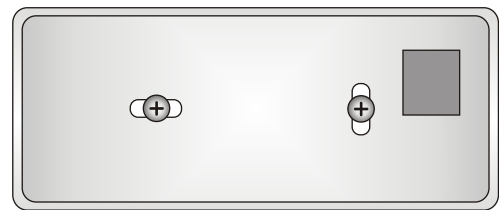
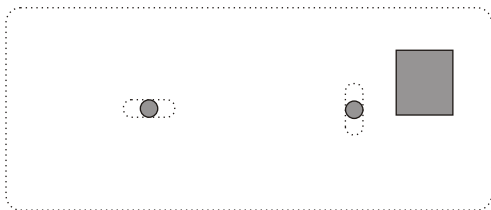

**2** Drill holes and make opening in wall using the marks drawn in the previous step. For plaster walls, drill two 1/4" holes and insert anchors for the mounting screws. Install the backplate onto the wall and run connecting cable.

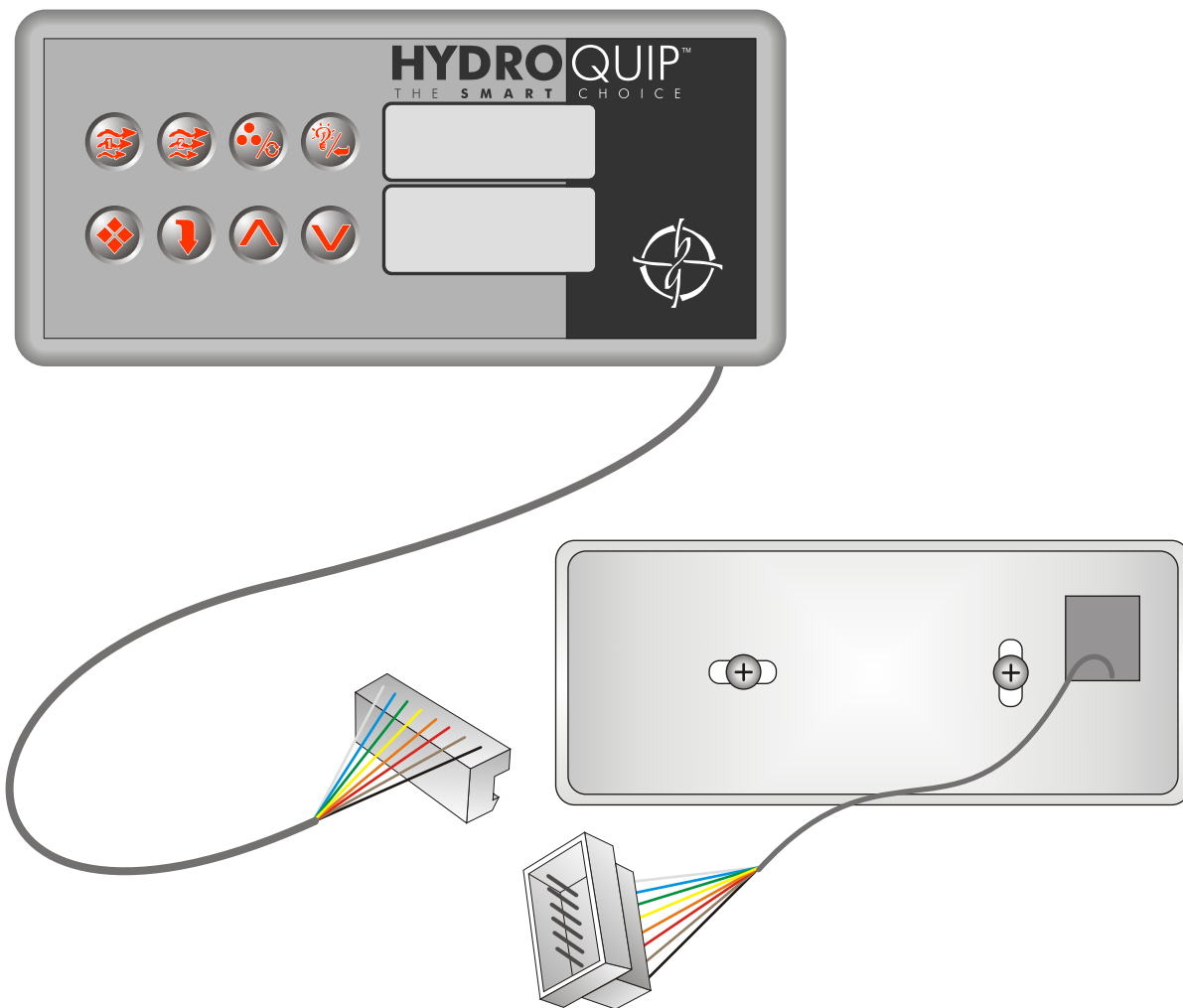

**3** Connect the In-House Control female connector to the male cord-end connector as illustrated above.

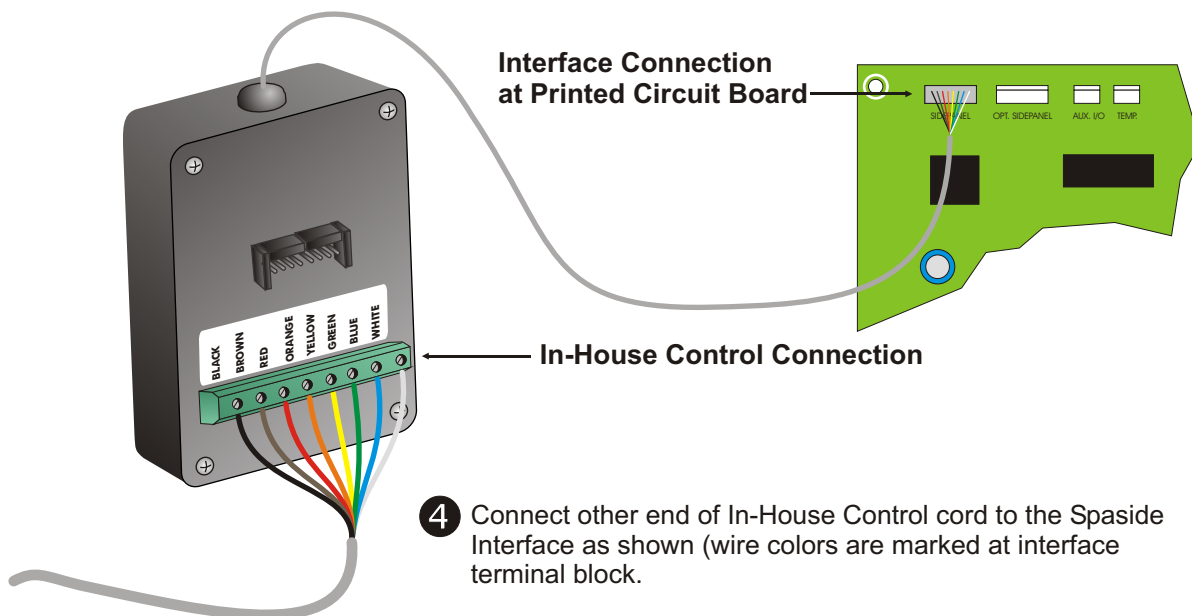

**4** Connect other end of In-House Control cord to the Spaside Interface as shown (wire colors are marked at interface terminal block).

*Note: The control connected to the standard connection of the Dual Interface (Spa Mounted control) will be recognized as the primary control if for any reason a key on the secondary (In-House) and primary are pressed simultaneously.*



**HYDROQUIP**<sup>TM</sup>

13345 Estelle Street • Corona, CA 92879-1881

Email: [hq@hydroquip.com](mailto:hq@hydroquip.com) • Internet: <http://www.hydroquip.com/>

Telephone: 909.273.7575 • Fax: 800.332.7190